

# Landau Levels

---

# Fermi sphere in a magnetic field

---

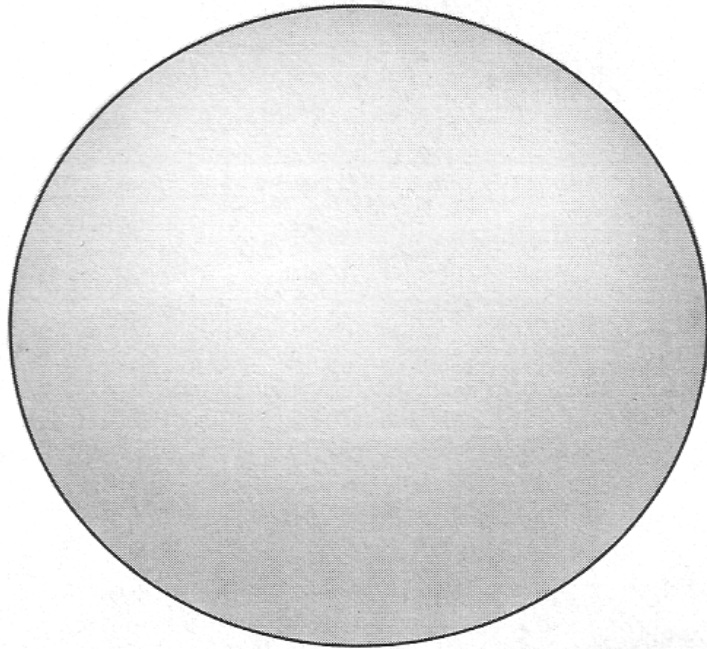

$B = 0$

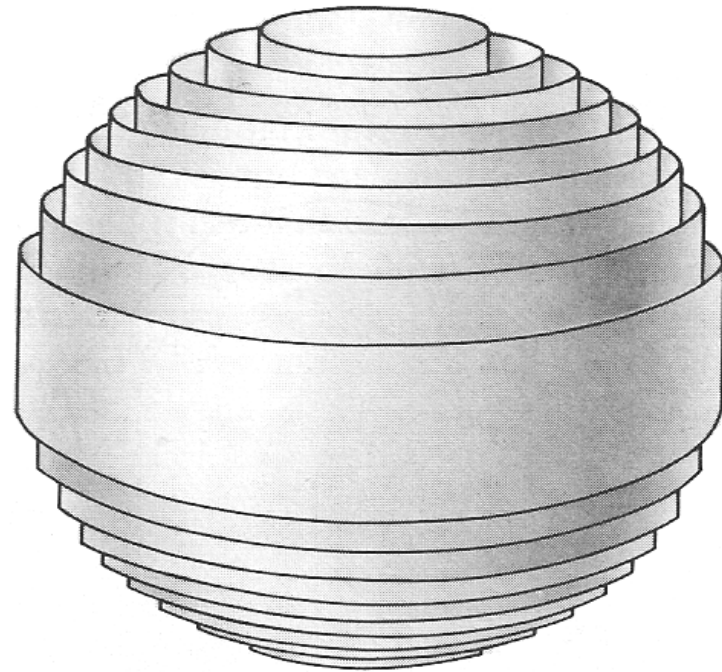

$B \neq 0$

Landau cylinders

# Density of states 3d

convolution of

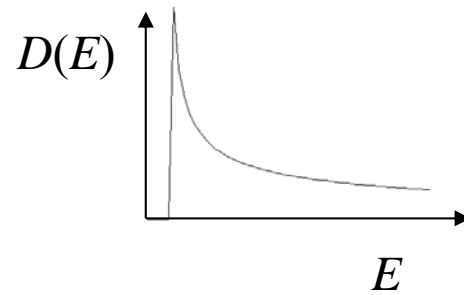

and

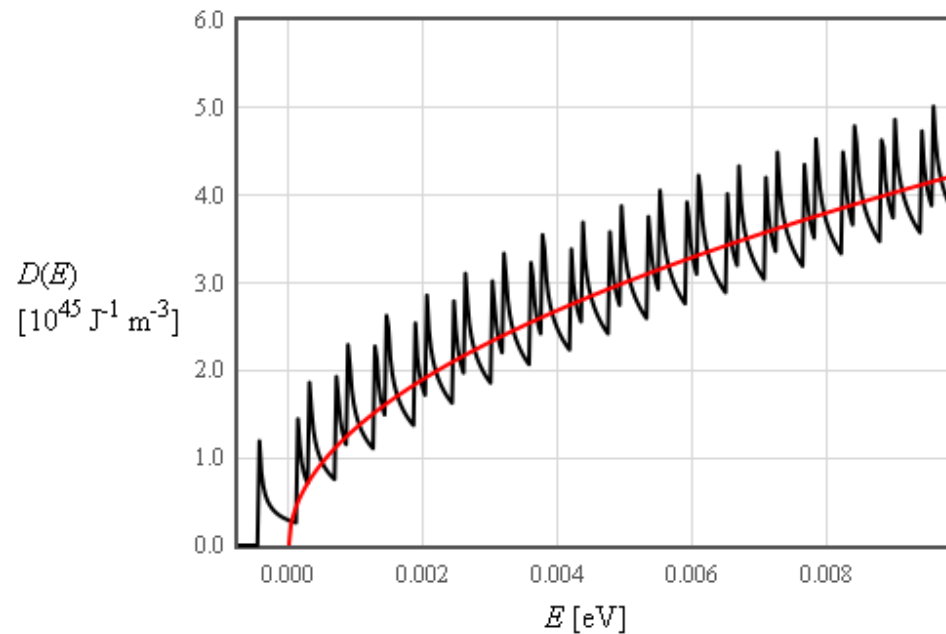
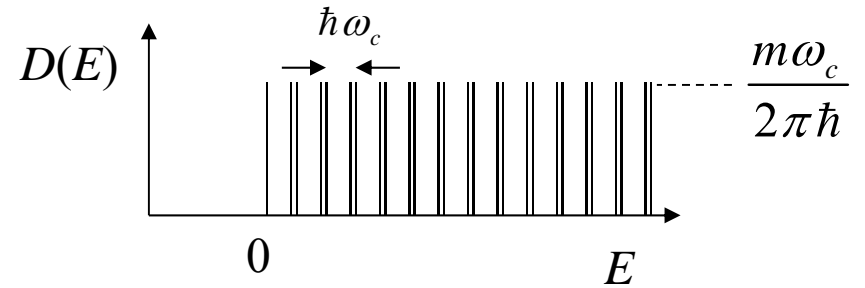

$$D(E) = \frac{(2m)^{3/2} \omega_c}{8\pi^2 \hbar^2} \left( \sum_{\nu=0}^{\infty} \frac{H(E - \hbar\omega_c (\nu + \frac{1}{2} - g/4))}{\sqrt{E - \hbar\omega_c (\nu + \frac{1}{2} - g/4)}} + \frac{H(E - \hbar\omega_c (\nu + \frac{1}{2} + g/4))}{\sqrt{E - \hbar\omega_c (\nu + \frac{1}{2} + g/4)}} \right) \text{ J}^{-1} \text{ m}^{-3}$$

Equation for free electrons in a magnetic field in 2 and 3 dimensions.

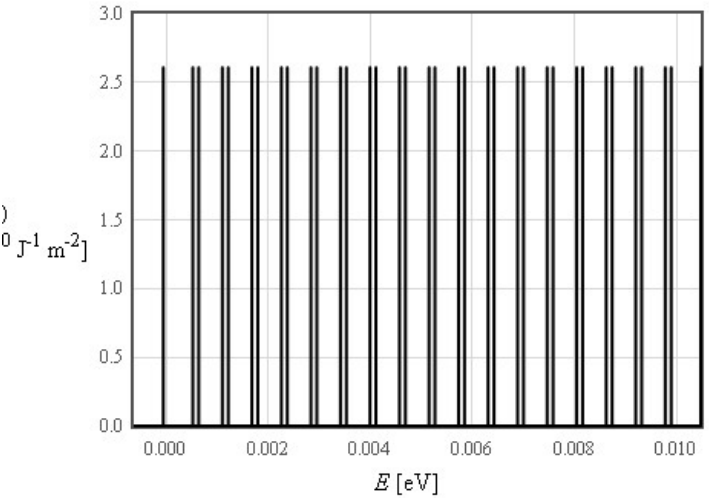
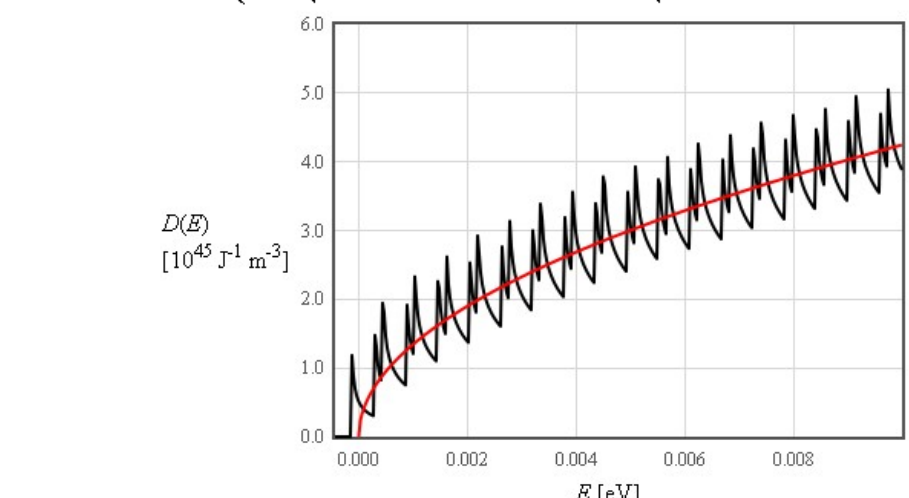
<p>2-D Schrödinger equation</p> $i\hbar \frac{d\psi}{dt} = \frac{1}{2m} (-i\hbar\nabla -  e \vec{A})^2 \psi$	<p>3-D Schrödinger equation</p> $i\hbar \frac{d\psi}{dt} = \frac{1}{2m} (-i\hbar\nabla -  e \vec{A})^2 \psi$
<p><math>\psi = g_v(x) \exp(ik_y y)</math>  <math>g_v(x)</math> is a harmonic oscillator wavefunction</p>	<p><math>\psi = g_v(x) \exp(ik_y y) \exp(ik_z z)</math>  <math>g_v(x)</math> is a harmonic oscillator wavefunction</p>
<p><math>E = \hbar\omega_c (v + \frac{1}{2}) \quad \text{J}</math>  <math>v = 0, 1, 2, \dots \quad \omega_c = \frac{ eB_z }{m}</math></p>	<p><math>E = \frac{\hbar^2 k_z^2}{2m} + \hbar\omega_c (v + \frac{1}{2}) \quad \text{J}</math>  <math>v = 0, 1, 2, \dots \quad \omega_c = \frac{ eB_z }{m}</math></p>
<p><math>\sum_{v=0}^{\infty} \delta\left(E - \hbar\omega_c (v + \frac{1}{2}) - \frac{g\mu_B}{2} B\right) + \delta\left(E - \hbar\omega_c (v + \frac{1}{2}) + \frac{g\mu_B}{2} B\right) \quad \text{J}^{-1}\text{m}^{-2}</math></p> 	<p><math>D(E) = \frac{(2m)^{3/2} \omega_c}{8\pi^2 \hbar^2} \left( \sum_{v=0}^{\infty} \frac{H(E - \hbar\omega_c (v + \frac{1}{2} - g/4))}{\sqrt{E - \hbar\omega_c (v + \frac{1}{2} - g/4)}} + \frac{H(E - \hbar\omega_c (v + \frac{1}{2} + g/4))}{\sqrt{E - \hbar\omega_c (v + \frac{1}{2} + g/4)}} \right) \quad \text{J}^{-1}\text{m}^{-3}</math></p> 

$$E_n = \hbar\omega \left( \text{Int} \left( \frac{\pi \hbar n}{\dots} \right) + \frac{1}{2} \right)$$

# Energy spectral density 3d

---

At  $T = 0$

$$u(E) = ED(E)f(E)$$

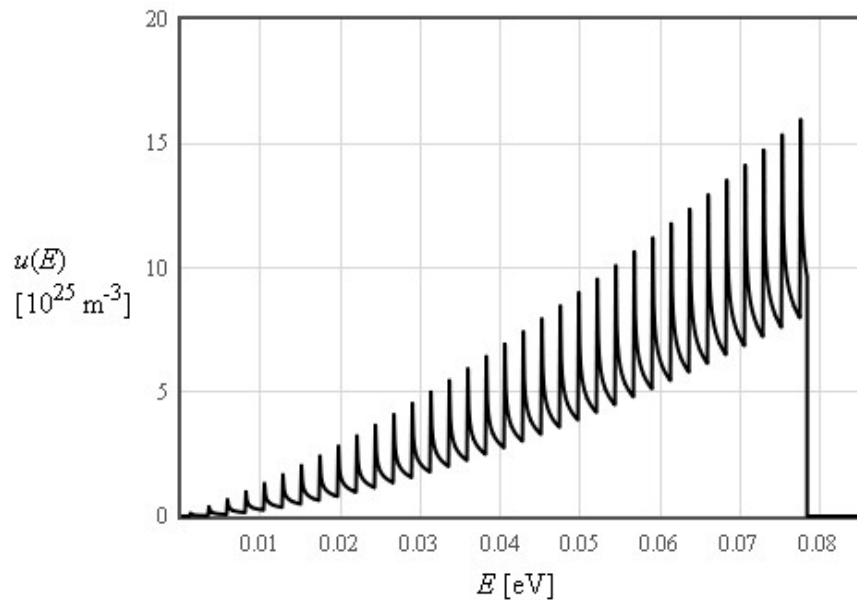

$$u(T = 0) = \int_{-\infty}^{E_F} ED(E)dE$$

# Fermi energy 3d

---

$$n = \int_{-\infty}^{E_F} D(E) dE$$

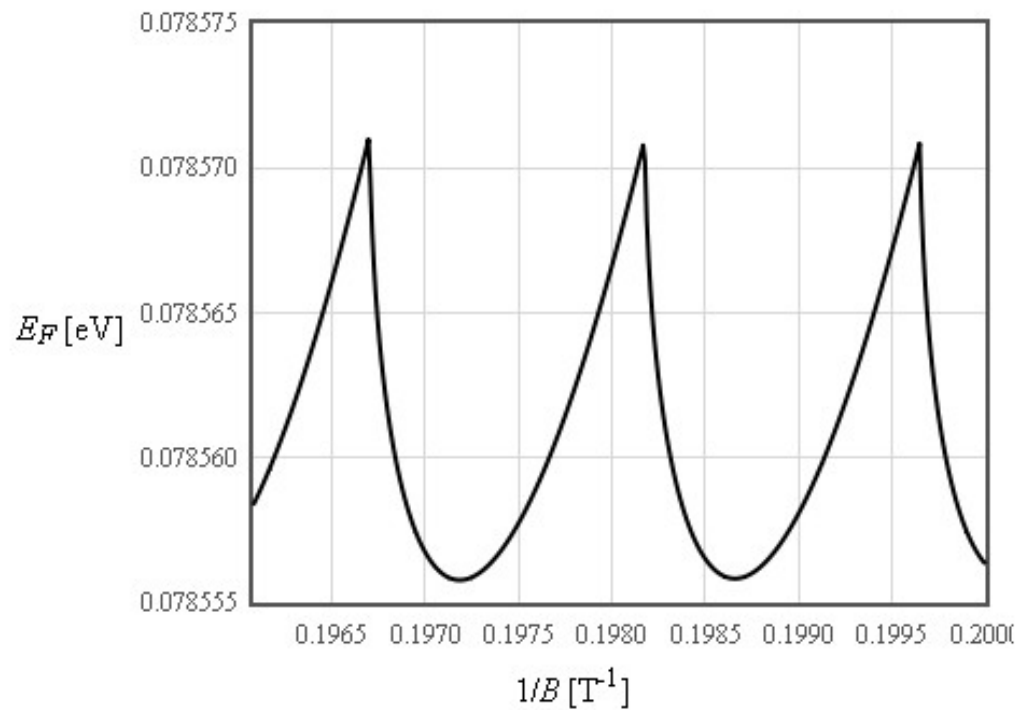

Periodic in  $1/B$

# Internal energy 3d

$$u = \int_{-\infty}^{E_F} E D(E) dE$$

At  $T = 0$

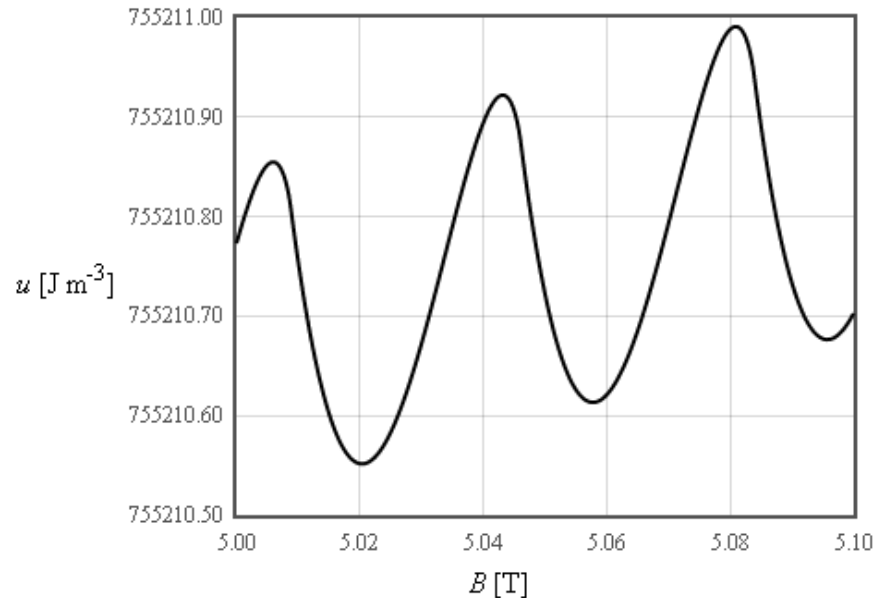

$$u = \frac{(2m)^{3/2} \omega_c}{4\pi^2 \hbar^2} \sum_{v=0}^{v < \frac{E_F}{\hbar\omega_c} - \frac{1}{2}} \int_{\hbar\omega_c(v+\frac{1}{2})}^{E_F} \frac{E dE}{\sqrt{E - \hbar\omega_c(v+\frac{1}{2})}} \quad \text{J m}^{-3}$$

$$u = \frac{(2m)^{3/2} \omega_c}{6\pi^2 \hbar^2} \sum_{v=0}^{v < \frac{E_F}{\hbar\omega_c} - \frac{1}{2}} (2\hbar\omega_c(v+\frac{1}{2}) + E_F) \sqrt{E_F - \hbar\omega_c(v+\frac{1}{2})} \quad \text{J m}^{-3}$$

# Magnetization 3d

---

$$m = -\frac{du}{dB}$$

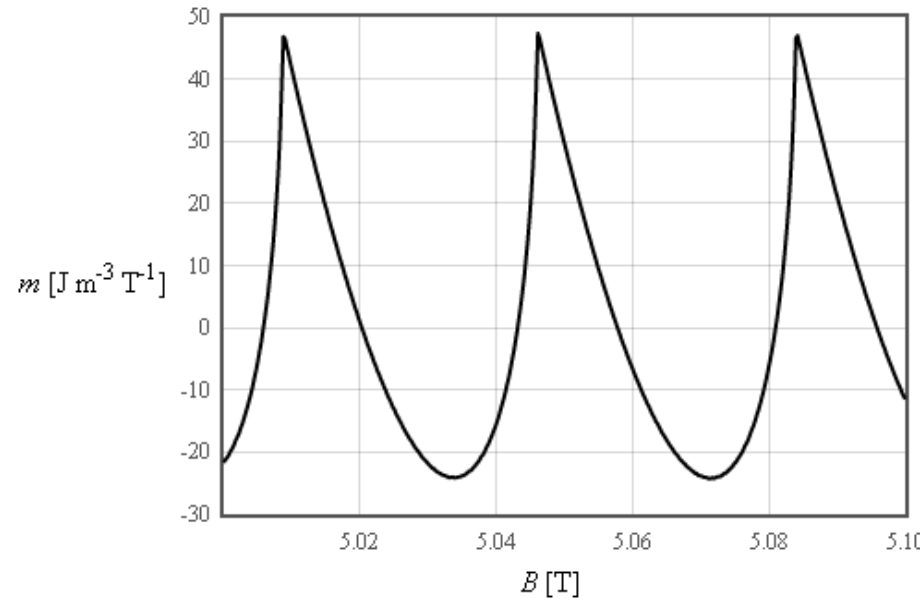

Periodic in  $1/B$

At finite temperatures this function would be smoother

de Haas - van Alphen oscillations



# Practically all properties are periodic in $1/B$

**Internal energy**

$$u = \int_{-\infty}^{\infty} ED(E)f(E)dE$$

**Specific heat**

$$c_v = \left( \frac{\partial u}{\partial T} \right)_{V=\text{const}}$$

**Entropy**

$$s = \int \frac{c_v}{T} dT$$

**Helmholtz free energy**

$$f = u - Ts$$

**Pressure**

$$P = - \left( \frac{\partial F}{\partial V} \right)_{T=\text{const}}$$

**Bulk modulus**

$$B = -V \frac{\partial P}{\partial V}$$

**Magnetization**

$$M = - \frac{dU}{dH}$$

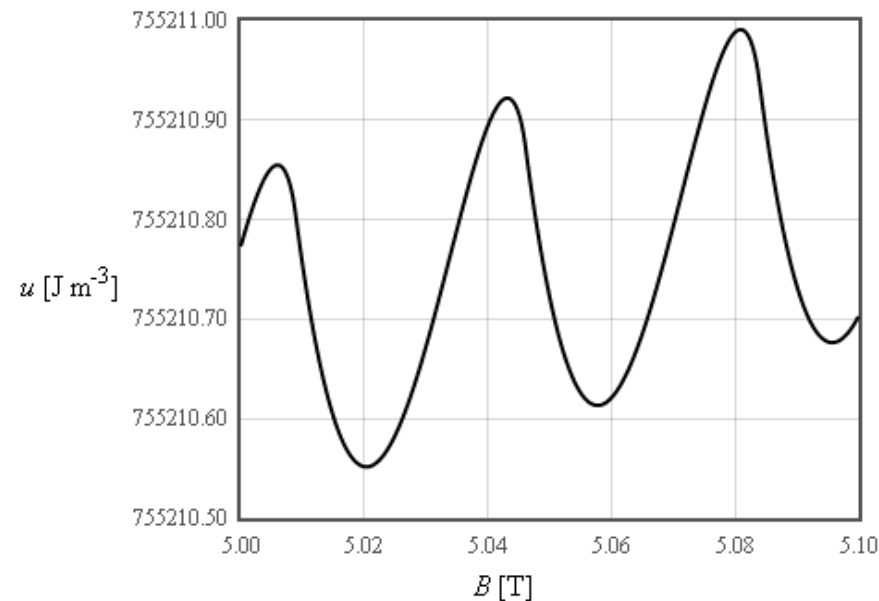

# Fermi sphere in a magnetic field

---

Cross sectional area  $S = \pi k_F^2$

$$\hbar \omega_c \left( \nu + \frac{1}{2} \right) = \frac{\hbar^2 k_F^2}{2m}$$

$$\hbar \frac{eB_\nu}{m} \left( \nu + \frac{1}{2} \right) = \frac{\hbar^2 k_F^2}{2m}$$

$$\frac{2\pi e}{\hbar} \left( \nu + 1 + \frac{1}{2} \right) = \frac{S}{B_{\nu+1}} \qquad \frac{2\pi e}{\hbar} \left( \nu + \frac{1}{2} \right) = \frac{S}{B_\nu}$$

Subtract right from left

$$S \left( \frac{1}{B_{\nu+1}} - \frac{1}{B_\nu} \right) = \frac{2\pi e}{\hbar}$$

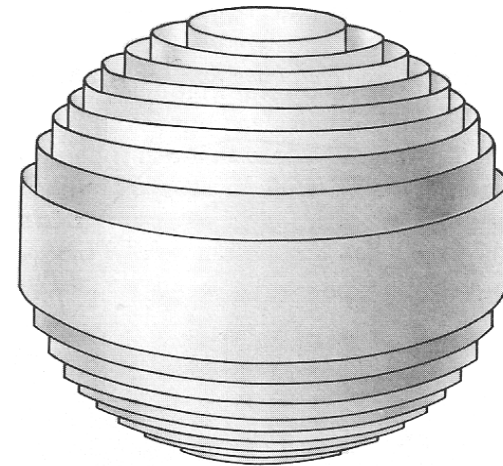

From the periodic of the oscillations, you can determine the cross sectional area  $S$ .

# Experimental determination of the Fermi surface

---

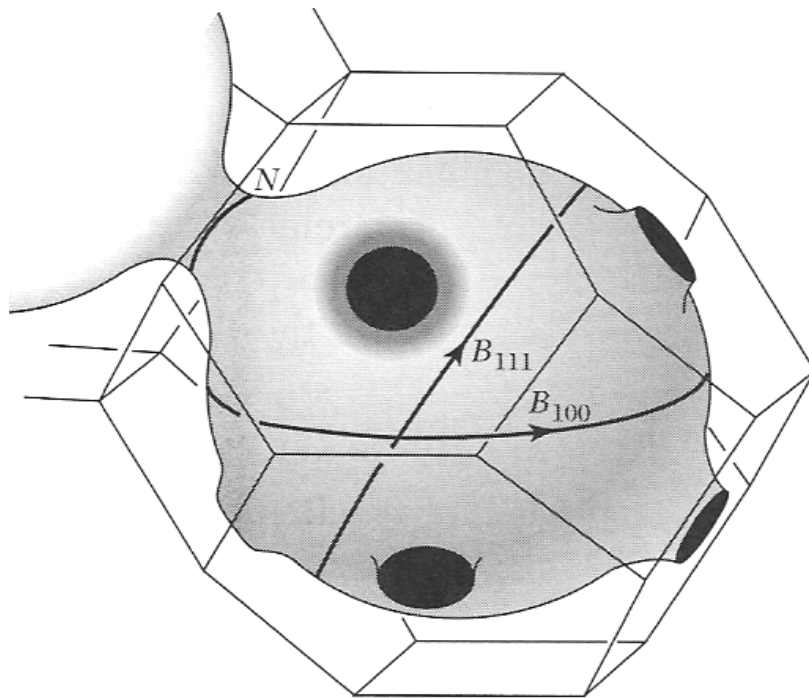

Kittel

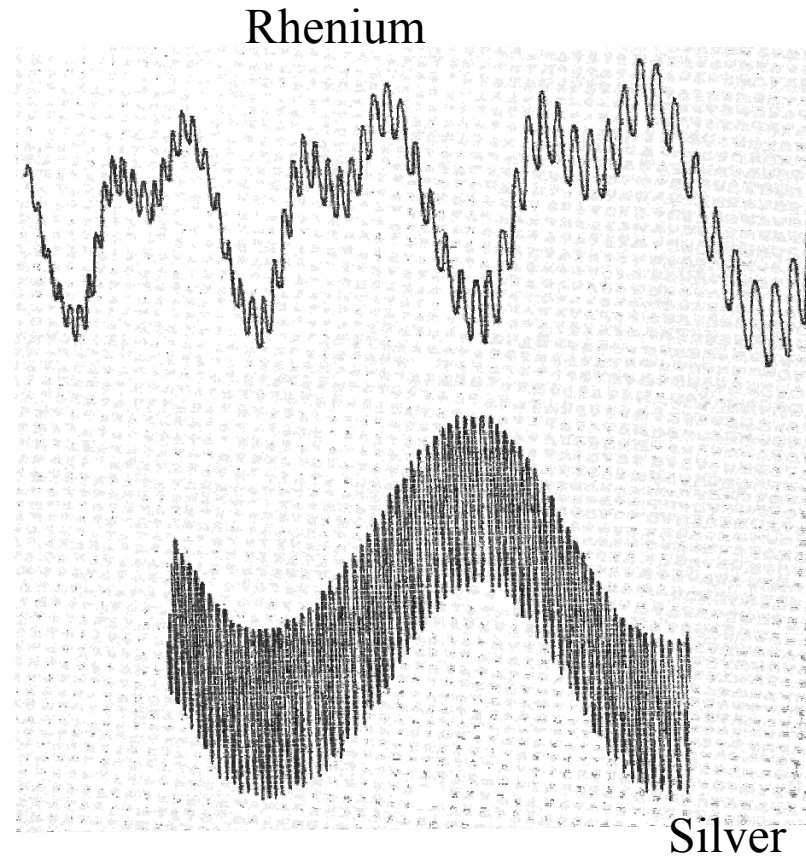

de Haas - van Alphen

# De Haas - van Alphen effect

The magnetic moment of gold oscillates periodically with  $1/B$

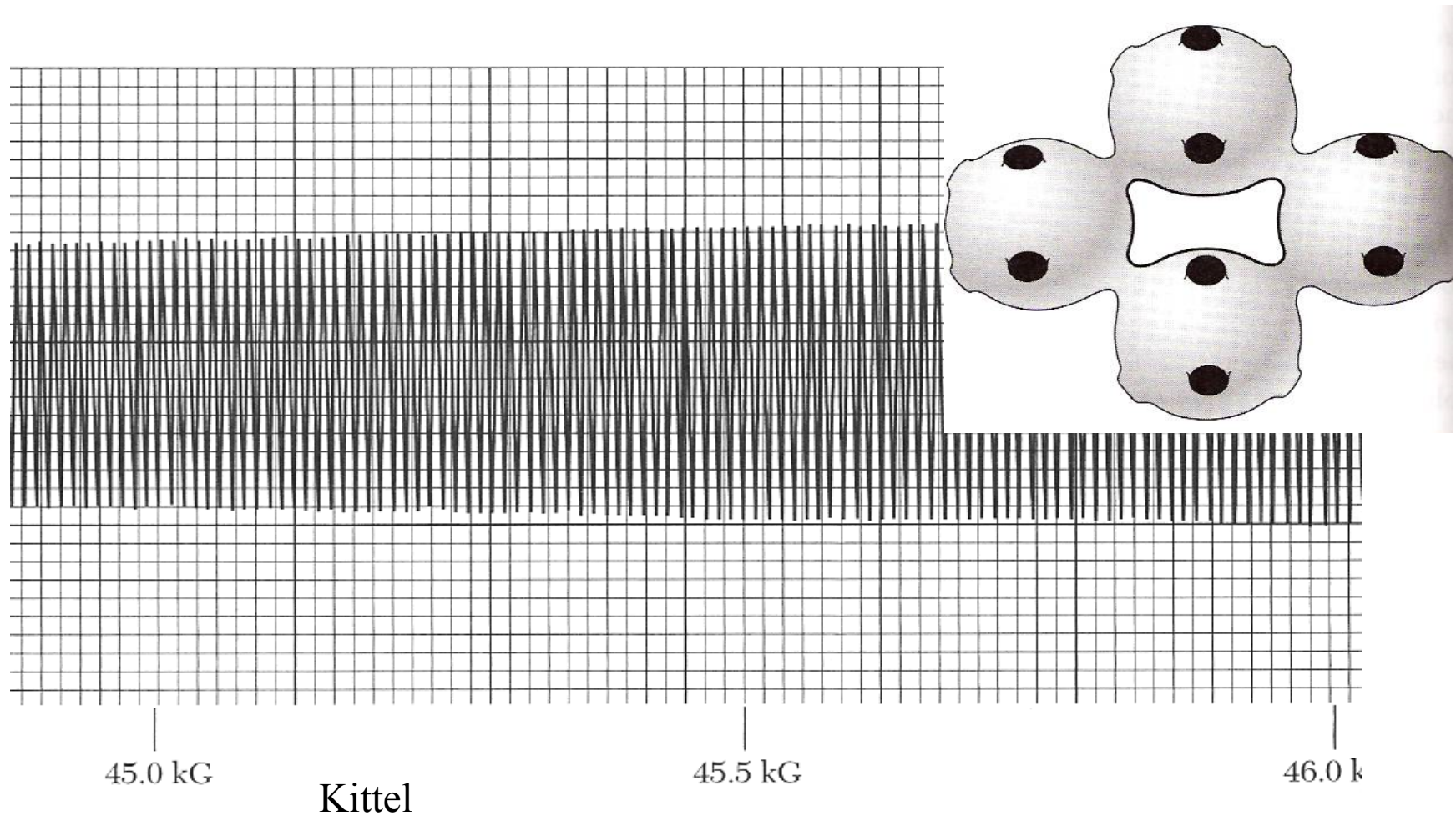

# Classical linear response theory

---

Fourier transforms  
Impulse response functions (Green's functions)  
Generalized susceptibility  
Causality  
Kramers-Kronig relations  
Fluctuation - dissipation theorem  
Dielectric function  
Optical properties of solids

# Impulse response function (Green's functions)

---

A Green's function is the solution to a linear differential equation for a  $\delta$ -function driving force

For instance, 
$$m \frac{d^2 g}{dt^2} + b \frac{dg}{dt} + kg = \delta(t)$$

has the solution

$$g(t) = \frac{1}{m} \exp\left(\frac{-bt}{2m}\right) \sin\left(\frac{\sqrt{4mk - b^2}}{2m} t\right) \quad t > 0$$

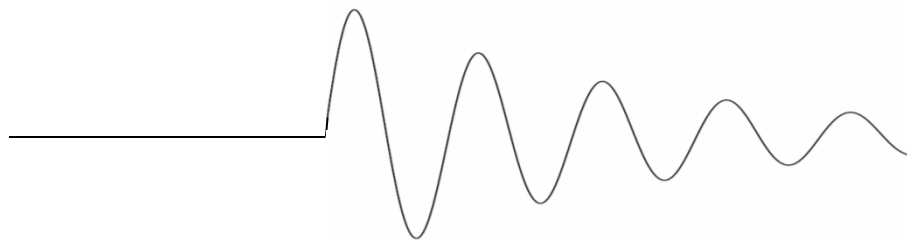

# Green's functions

---

A driving force  $f$  can be thought of as being built up of many delta functions after each other.

$$f(t) = \int \delta(t - t') f(t') dt'$$

By superposition, the response to this driving function is superposition,

$$u(t) = \int g(t - t') f(t') dt'$$

For instance, 
$$m \frac{d^2 u}{dt^2} + b \frac{du}{dt} + ku = f(t)$$

has the solution

$$u(t) = \int_{-\infty}^{\infty} \frac{1}{m} \exp\left(\frac{-b(t-t')}{2m}\right) \sin\left(\frac{\sqrt{4mk - b^2}}{2m}(t-t')\right) f(t') dt'$$

Green's function converts a differential equation into an integral equation

# Generalized susceptibility

---

A driving function  $f$  causes a response  $u$

If the driving force is sinusoidal,

$$f(t) = F_0 e^{i\omega t}$$

The response will also be sinusoidal.

$$u(t) = \int g(t-t') f(t') dt' = \int g(t-t') F_0 e^{i\omega t'} dt'$$

The generalized susceptibility at frequency  $\omega$  is

$$\chi(\omega) = \frac{u}{f} = \frac{\int g(t-t') e^{i\omega t'} dt'}{e^{i\omega t}}$$



# Generalized susceptibility

---

$$\chi(\omega) = \frac{u}{f} = \frac{\int g(t-t')e^{i\omega t'} dt'}{e^{i\omega t}}$$

Since the integral is over  $t'$ , the factor with  $t$  can be put in the integral.

$$\chi(\omega) = \int g(t-t')e^{-i\omega(t-t')} dt'$$

Change variables to  $\tau = t - t'$

$$\chi(\omega) = \int g(\tau)e^{-i\omega\tau} d\tau$$

The susceptibility is the Fourier transform (notation [1,-1]) of the Green's function.

$$g(t) = \frac{1}{2\pi} \int \chi(\omega)e^{i\omega t} d\omega$$

# Fourier Transforms

---

$$f(\vec{r}) = \int F(\vec{k}) \exp(i\vec{k} \cdot \vec{r}) d\vec{k}$$

↑  
The Fourier transform of  $f(r)$ .

All information about  $f(r)$  is contained in its Fourier transform.

All information about  $F(k)$  is contained in  $f(r)$ .

$$F(\vec{k}) = \frac{1}{(2\pi)^d} \int f(\vec{r}) \exp(-i\vec{k} \cdot \vec{r}) d\vec{r}$$

$d$  is the number of dimensions

# Fourier Transforms: plane waves

---

Plane waves have the form:  $\exp(i\vec{k} \cdot \vec{r}) = \cos(\vec{k} \cdot \vec{r}) + i \sin(\vec{k} \cdot \vec{r})$

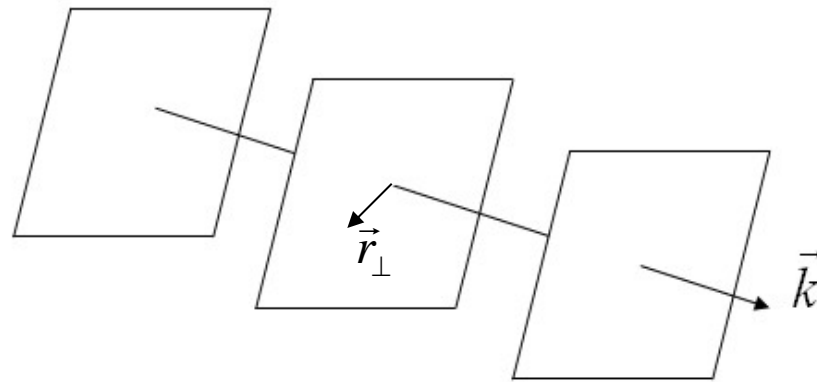

$$\exp(i\vec{k} \cdot (\vec{r} + \vec{r}_\perp)) = \exp(i\vec{k} \cdot \vec{r})$$

Often convenient to work with functions expressed in terms of plane waves

$$f(\vec{r}) = \sum_{\vec{G}} F_{\vec{G}} \exp(i\vec{G} \cdot \vec{r})$$

Periodic functions

$$f(\vec{r}) = \int F(\vec{k}) \exp(i\vec{k} \cdot \vec{r}) d\vec{k}$$

Any functions

# Fourier Transforms

---

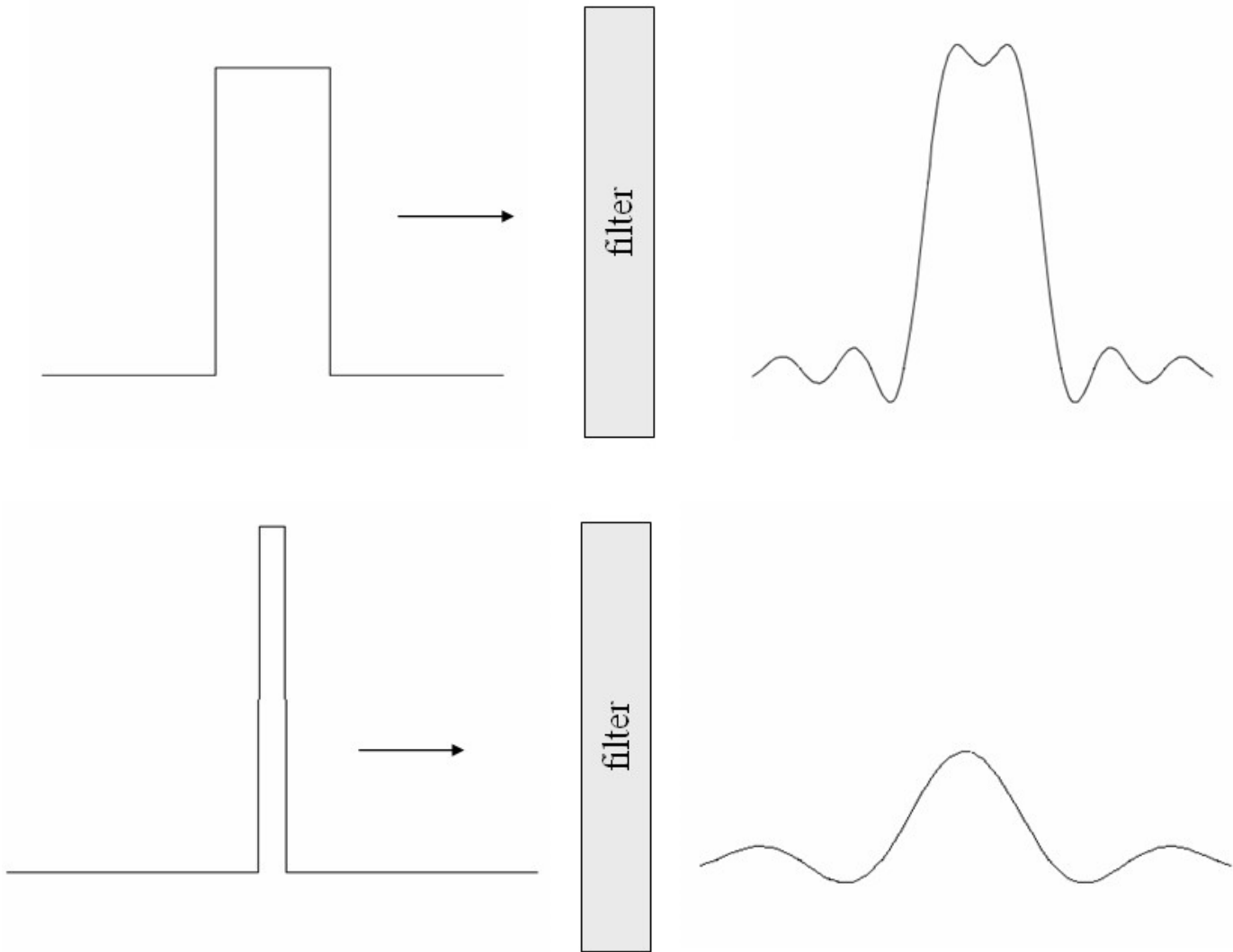

# Notation

---

[a,b]

$$F_{[a,b]}(\vec{k}) = \sqrt{\frac{|b|^d}{(2\pi)^{d(1-a)}}} \int f(\vec{r}) \exp(i\vec{k} \cdot \vec{r}) d\vec{r}$$

$$f(\vec{r}) = \sqrt{\frac{|b|^d}{(2\pi)^{d(1+a)}}} \int F_{[a,b]}(\vec{k}) \exp(-i\vec{k} \cdot \vec{r}) d\vec{k}$$

MathWorld

# Notation

[-1,-1]

$$F(\vec{k}) = \frac{1}{(2\pi)^d} \int f(\vec{r}) \exp(-i\vec{k} \cdot \vec{r}) d\vec{r}$$

$$f(\vec{r}) = \int F(\vec{k}) \exp(i\vec{k} \cdot \vec{r}) d\vec{k}$$

[1,-1]

$$F(\vec{k}) = \int f(\vec{r}) \exp(-i\vec{k} \cdot \vec{r}) d\vec{r}$$

$$f(\vec{r}) = \frac{1}{(2\pi)^d} \int F(\vec{k}) \exp(i\vec{k} \cdot \vec{r}) d\vec{k}$$

Matlab

[0,-1]

$$F(\vec{k}) = \frac{1}{(2\pi)^{d/2}} \int f(\vec{r}) \exp(-i\vec{k} \cdot \vec{r}) d\vec{r}$$

$$f(\vec{r}) = \frac{1}{(2\pi)^{d/2}} \int F(\vec{k}) \exp(i\vec{k} \cdot \vec{r}) d\vec{k}$$

Evertz, Mathematica uses [0,1]

[0,-2π]

$$F(\vec{q}) = \int f(\vec{r}) \exp(-i2\pi\vec{q} \cdot \vec{r}) d\vec{r}$$

$$f(\vec{r}) = \int F(\vec{q}) \exp(i2\pi\vec{q} \cdot \vec{r}) d\vec{q}$$

$$\lambda = \frac{1}{|\vec{q}|}$$

Engineering literature