

# Extrinsic semiconductors

---

# Donors

Five valence electrons: P, As

States are added in the band gap just below the conduction band

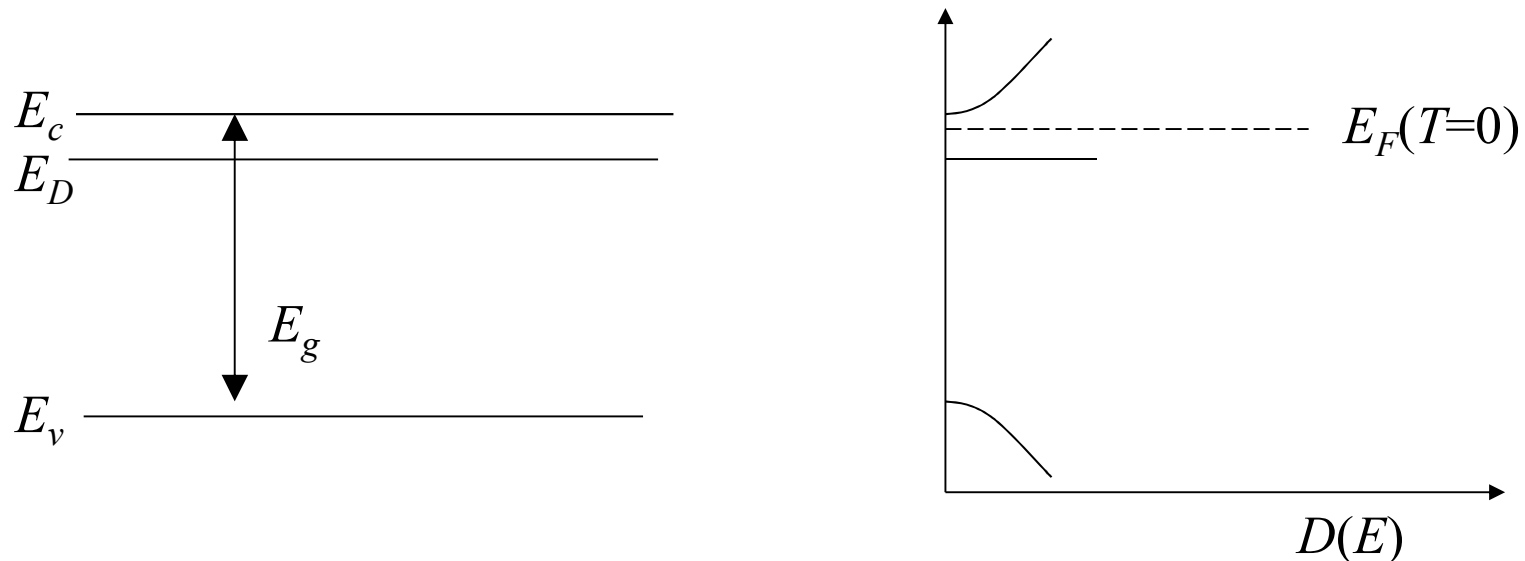

n-type:  $n \sim N_D$  Many more electrons in the conduction band than holes in the valence band.

majority carriers: electrons; minority carriers: holes

# Acceptors

Three valence electrons: B, Al, Ga

States are added in the band gap just above the valence band

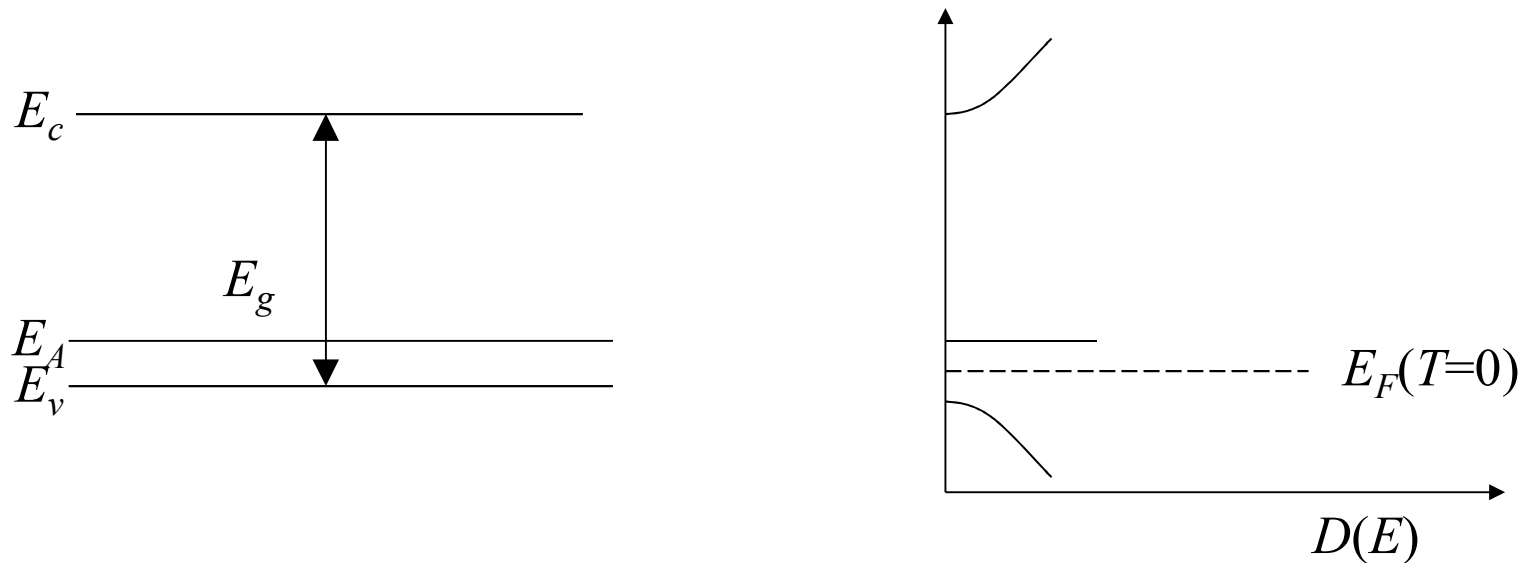

p-type:  $p \sim N_A$  Many more holes in the valence band than electrons in the conduction band.

majority carriers: holes; minority carriers: electrons

# Donor and Acceptor Energies

---

Semiconductor	Donor	Energy (meV)
Si	Li	33
	Sb	39
	P	45
	As	54
Ge	Li	9.3
	Sb	9.6
	P	12
	As	13
GaAs	Si	5.8
	Ge	6.0
	S	6.0
	Sn	6.0

Energy below the conduction band



Semiconductor	Acceptor	Energy (meV)
Si	B	45
	Al	67
	Ga	72
	In	160
Ge	B	10
	Al	10
	Ga	11
	In	11
GaAs	C	26
	Be	28
	Mg	28
	Si	35

Energy above the valence band



## Direct Observation of Friedel Oscillations around Incorporated $\text{Si}_{\text{Ga}}$ Dopants in GaAs by Low-Temperature Scanning Tunneling Microscopy

M. C. M. M. van der Wielen, A. J. A. van Roij, and H. van Kempen

*Research Institute for Materials, University of Nijmegen, Toernooiveld 1, 6525 ED Nijmegen, The Netherlands*

(Received 25 July 1995)

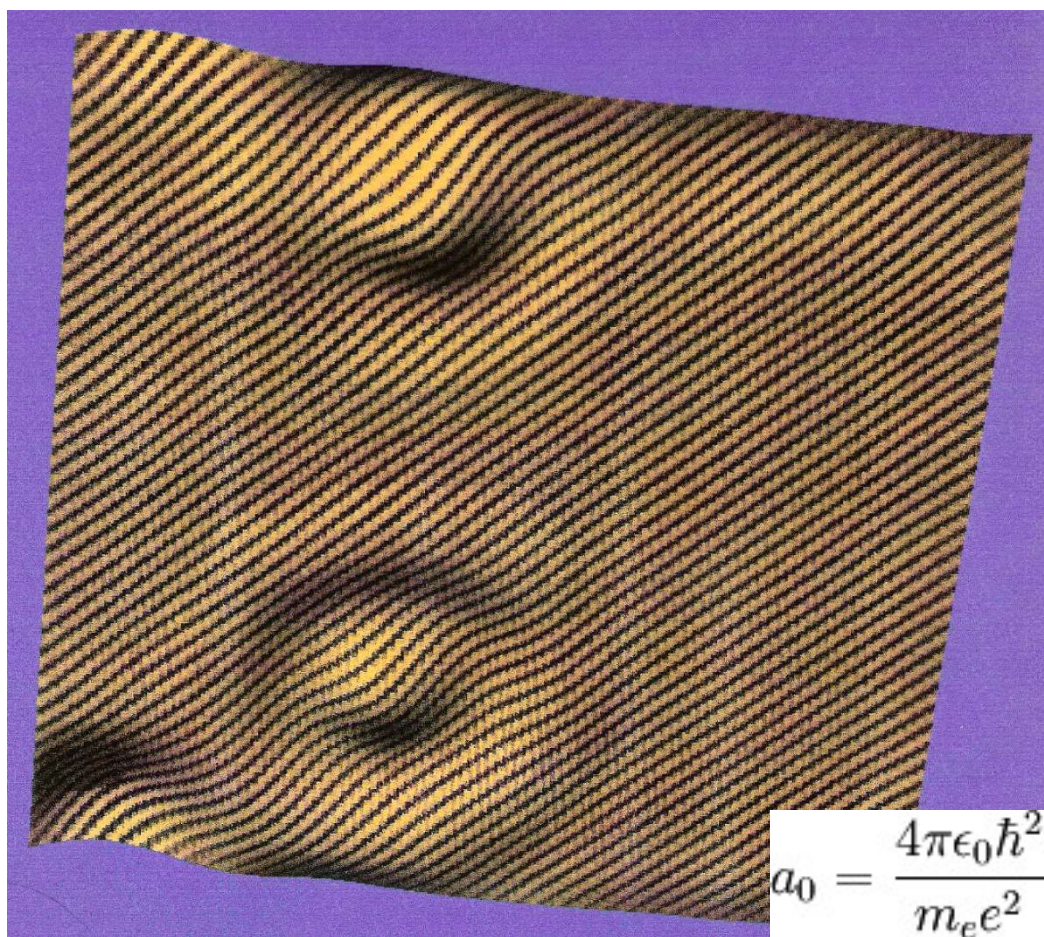

$$a_0 = \frac{4\pi\epsilon_0\hbar^2}{m_e e^2}$$

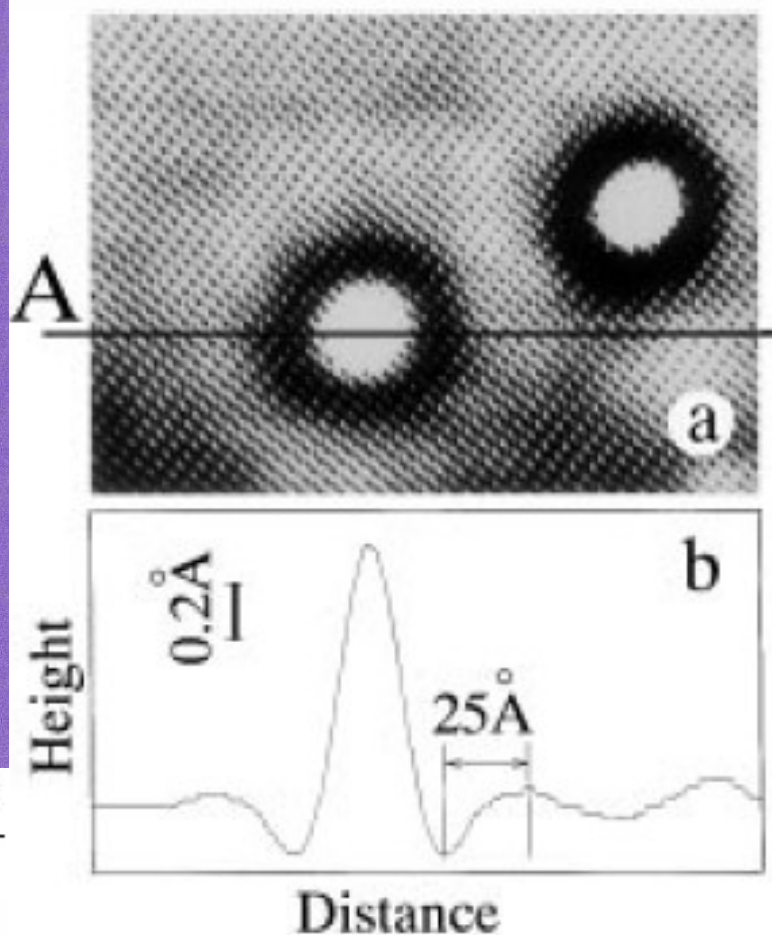

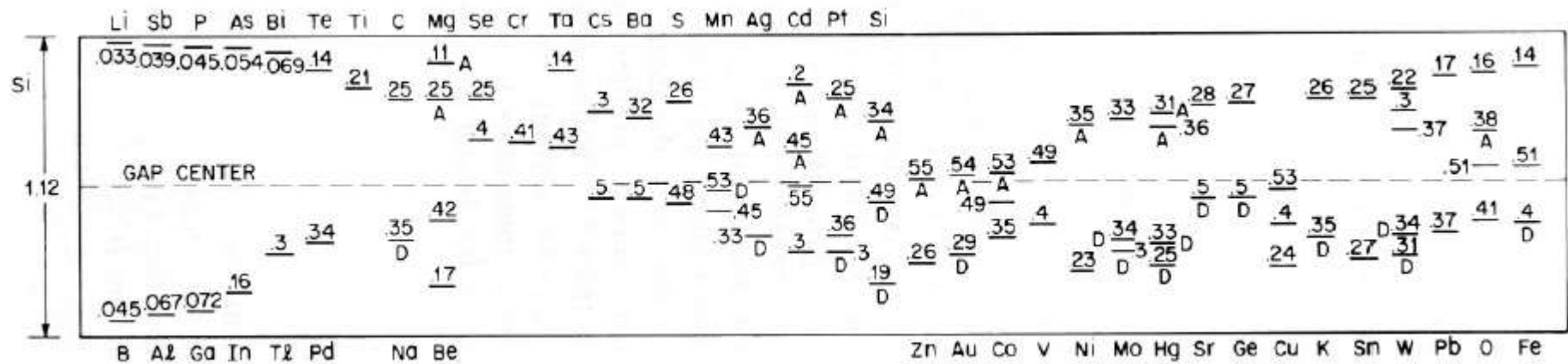

Source: Semiconductor Devices Physics and Technology, S.M. Sze, 1985

# Extrinsic semiconductors

---

## Dopants

### Donors

Examples: P, As in Si.

Mobile negative electrons

Fixed positive donors

### Acceptors

Examples: B, Ga in Si.

Mobile positive holes

Fixed negative acceptors

## Charge Neutrality

$$n + N_A^- = p + N_D^+$$

$$n = N_c(T) \exp\left(\frac{E_F - E_c}{k_B T}\right)$$

$$p = N_v(T) \exp\left(\frac{E_v - E_F}{k_B T}\right)$$

# Temperature dependence

---

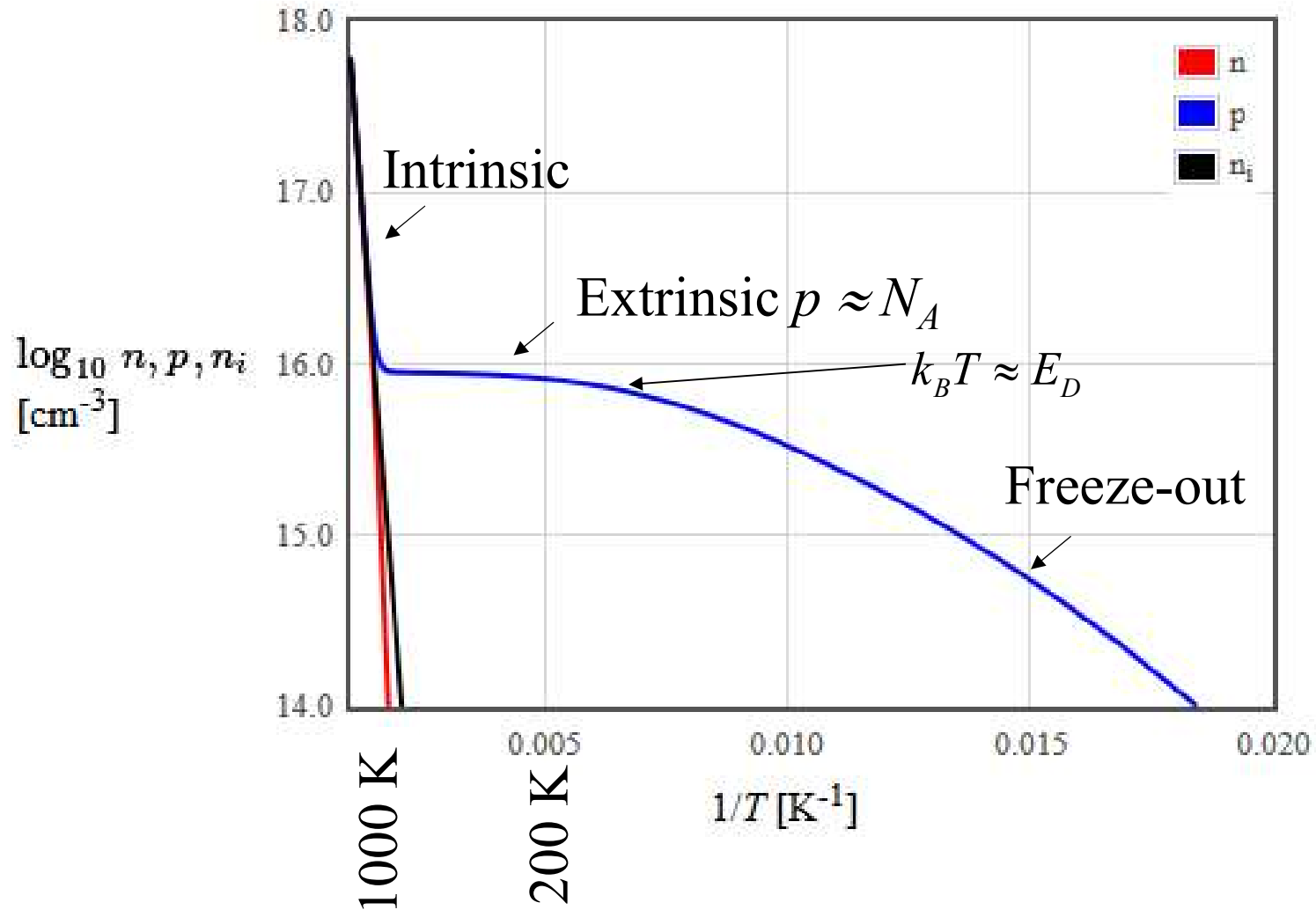



# Ionized donors and acceptors

---

For  $E_v + 3k_B T < E_F < E_c - 3k_B T$  Boltzmann approximation

$$N_D^+ = \frac{N_D}{1 + 2 \exp\left(\frac{E_F - E_D}{k_B T}\right)} \qquad N_A^- = \frac{N_A}{1 + 4 \exp\left(\frac{E_A - E_F}{k_B T}\right)}$$

4 for materials with light holes and heavy holes (Si)  
2 otherwise

$N_D$  = donor density  $\text{cm}^{-3}$        $N_D^+$  = ionized donor density  $\text{cm}^{-3}$

$N_A$  = acceptor density  $\text{cm}^{-3}$        $N_A^-$  = ionized acceptor density  $\text{cm}^{-3}$

Mostly,  $N_D^+ = N_D$  and  $N_A^- = N_A$

# Charge neutrality

$$n + N_A^- = p + N_D^+$$

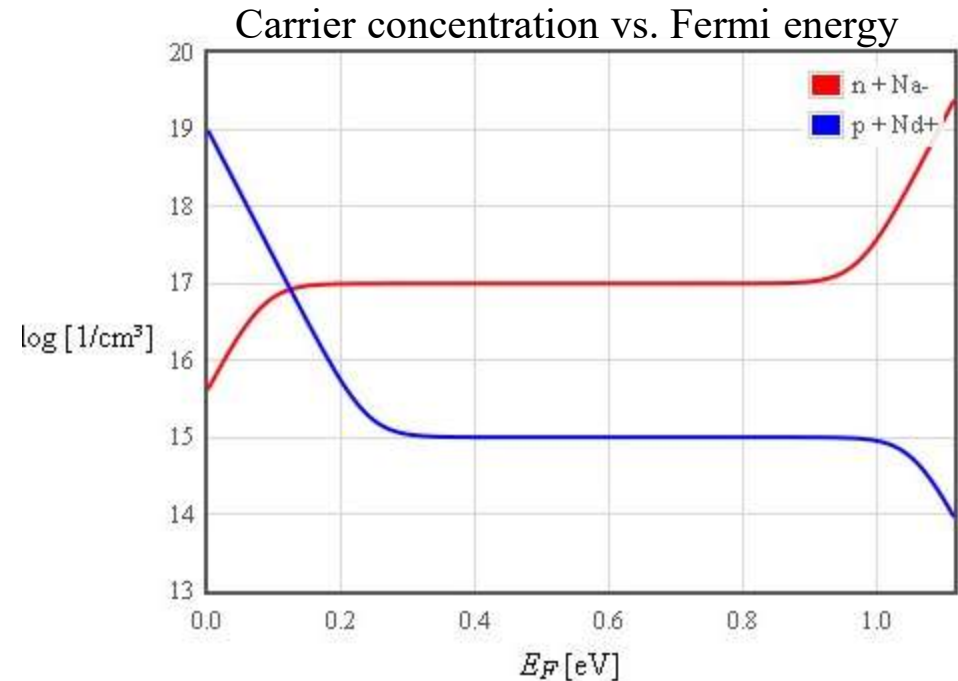

```

for ($i=0; $i<500; $i++) {
    $Ef = $i*$Eg/500;
    $n=$Nc*pow($T/300,1.5)*exp(1.6022E-19*($Ef-$Eg)/(1.38E-23*$T));
    $p=$Nv*pow($T/300,1.5)*exp(1.6022E-19*(-$Ef)/(1.38E-23*$T));
    $Namin = $Na/(1+4*exp(1.6022E-19*($Ea-$Ef)/(1.38E-23*$T)));
    $Ndplus = $Nd/(1+2*exp(1.6022E-19*($Ef-$Ed)/(1.38E-23*$T)));
}
    
```

$E_f$	$n$	$p$	$N_d^+$	$N_a^-$	$\log(n+N_a^-)$	$\log(p+N_d^+)$
0	4.16629283405	9.84E+18	1E+15	4.19743393218E+15	15.622983869	18.9930392318
0.00224	4.54358211887	9.0229075682E+18	1E+15	4.56020949614E+15	15.6589847946	18.9553946382
0.00448	4.95503779816	8.27366473417E+18	1E+15	4.95271809535E+15	15.694843609	18.9177504064
0.00672	5.40375389699	7.58663741327E+18	1E+15	5.37710747619E+15	15.7305487171	18.8801065693
0.00896	5.89210460791	6.95665026215E+18	1E+15	5.8256000025E+15	15.7660076057	18.8404621605

## Fermi energy vs. temperature

Fermi energy of an extrinsic semiconductor is plotted as a function of temperature. At each temperature the Fermi energy was calculated by requiring that charge neutrality be satisfied.

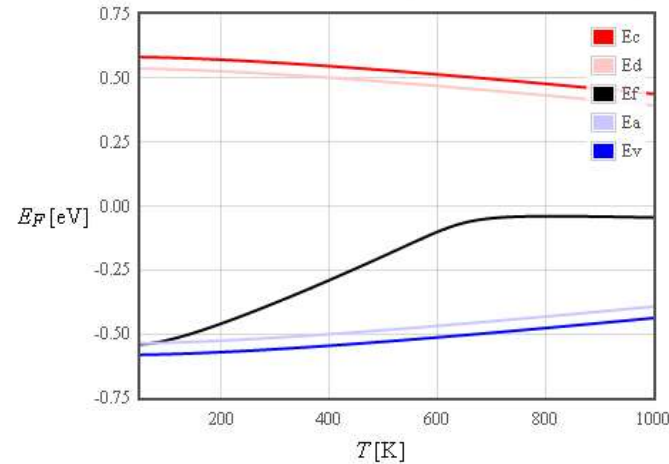

$N_c(300\text{ K}) = 2.78\text{E}19$	1/cm <sup>3</sup>	Semiconductor <input type="button" value="Si"/> <input type="button" value="Ge"/> <input type="button" value="GaAs"/>
$N_v(300\text{ K}) = 9.84\text{E}18$	1/cm <sup>3</sup>	
$E_g = 1.166 - 4.73\text{E} - 4 * T * T / (T + 636)$		eV
$N_d = 1\text{E}15$	1/cm <sup>3</sup>	Donor <input type="button" value="P in Si"/> <input type="button" value="P in Ge"/> <input type="button" value="Si in GaAs"/>
$E_c - E_d = 0.045$	eV	
$N_a = 1\text{E}16$	1/cm <sup>3</sup>	Acceptor <input type="button" value="B in Si"/> <input type="button" value="B in Ge"/> <input type="button" value="Si in GaAs"/>
$E_a - E_v = 0.045$	eV	
$T_1 = 50$	K	
$T_2 = 1000$	K	
<input type="button" value="Replot"/>		

Once the Fermi energy is known, the carrier densities  $n$  and  $p$  can be calculated from the formulas,  $n = N_c \left(\frac{T}{300}\right)^{3/2} \exp\left(\frac{E_F - E_c}{k_B T}\right)$  and  $p = N_v \left(\frac{T}{300}\right)^{3/2} \exp\left(\frac{E_v - E_F}{k_B T}\right)$ .

The intrinsic carrier density is  $n_i = \sqrt{N_c \left(\frac{T}{300}\right)^{3/2} N_v \left(\frac{T}{300}\right)^{3/2} \exp\left(\frac{-E_g}{2k_B T}\right)}$ .

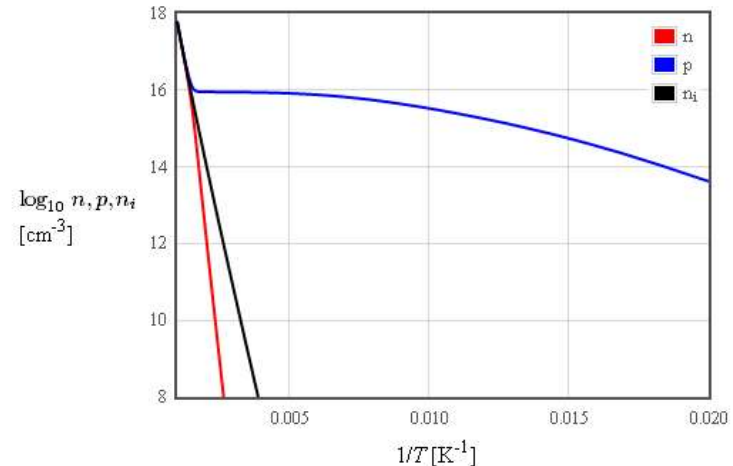
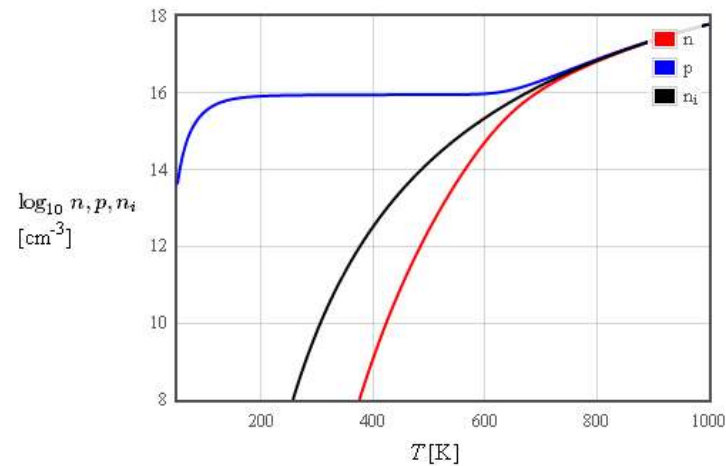

<http://lamp.tu-graz.ac.at/~hadley/psd/L4/eftplot.html>

# Intrinsic semiconductors

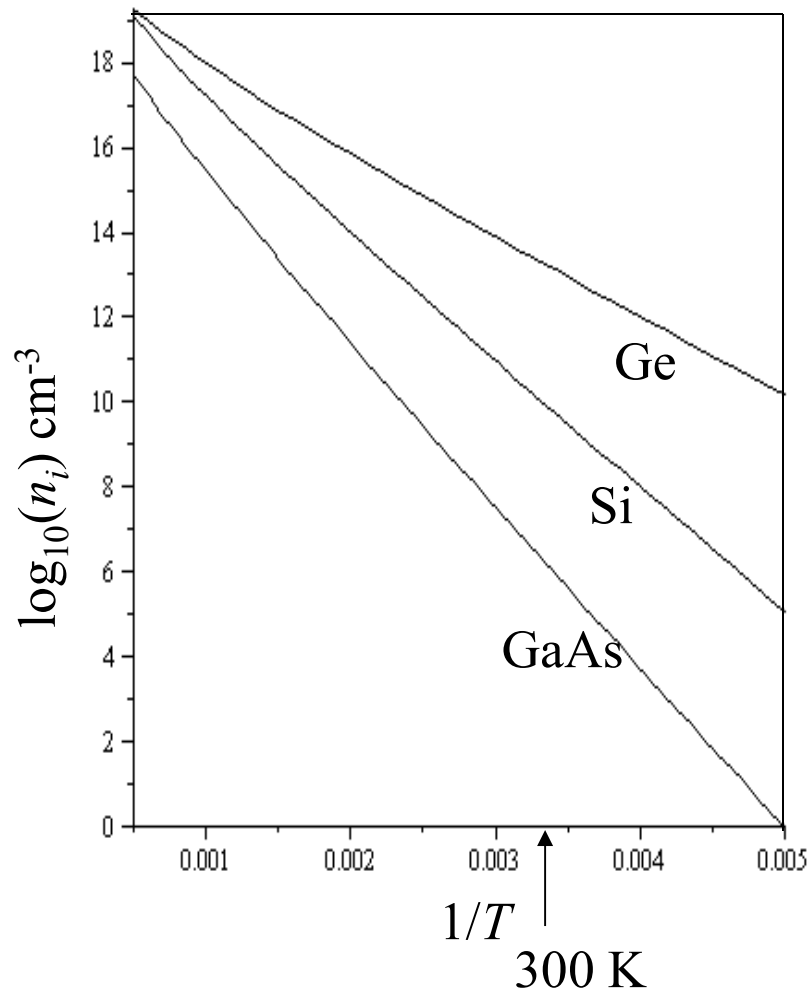

$$n_i = \sqrt{N_v N_c} \exp\left(-\frac{E_g}{2k_B T}\right)$$

# Extrinsic semiconductors

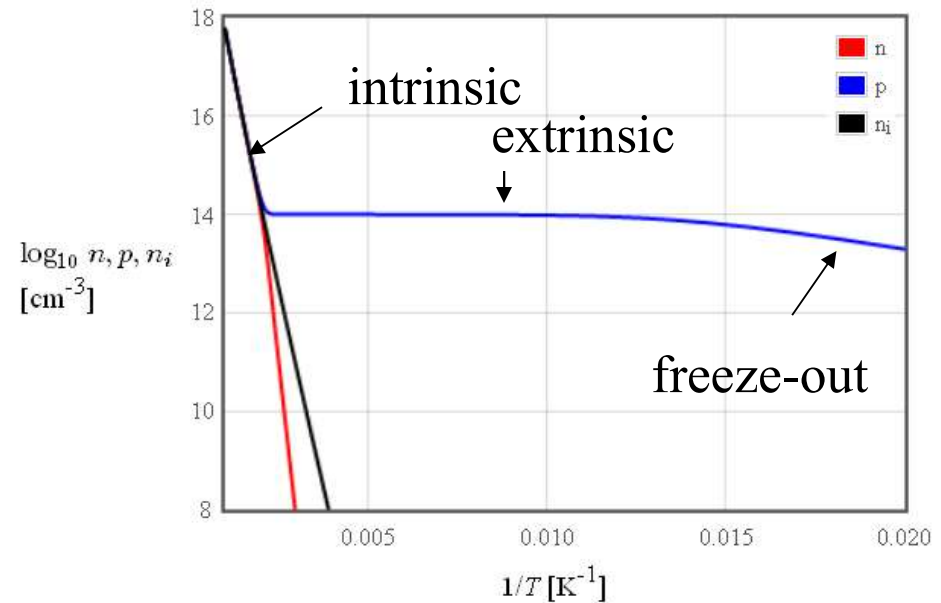

At high temperatures, extrinsic semiconductors have the same temperature dependence as intrinsic semiconductors.

# n-type (extrinsic)

$$n = N_D = N_c \exp\left(\frac{E_F - E_c}{k_B T}\right)$$

$$E_F = E_c - k_B T \ln\left(\frac{N_c}{N_D}\right)$$

For n-type,  $n \sim$  density of donors,  
 $p = n_i^2 / N_D$

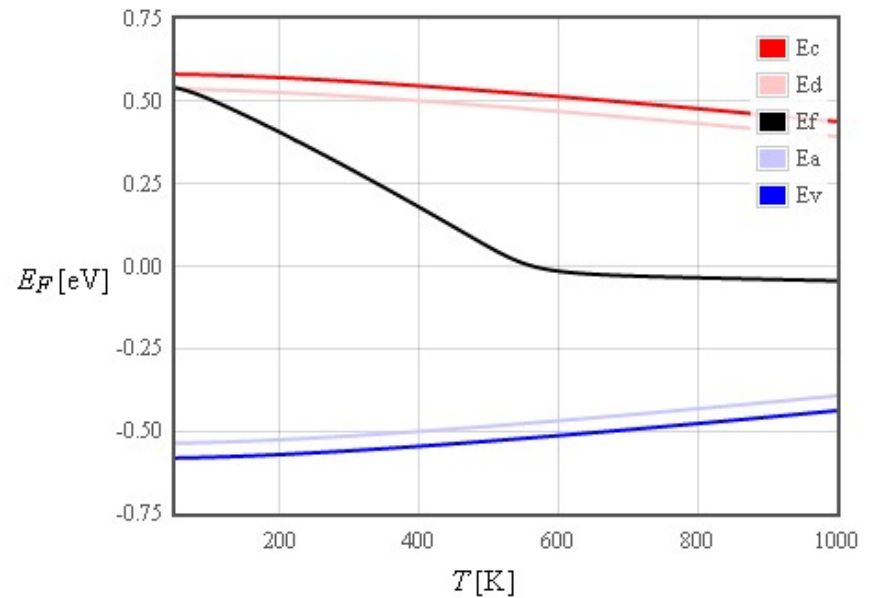
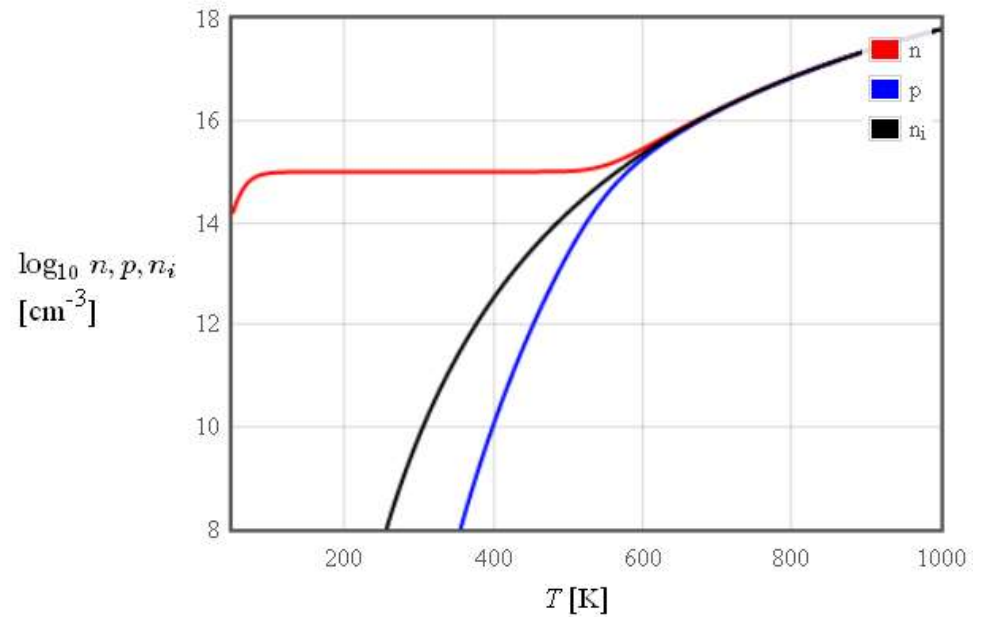

# p-type (extrinsic)

$$p = N_A = N_v \exp\left(\frac{E_v - E_F}{k_B T}\right)$$

$$E_F = E_v + k_B T \ln\left(\frac{N_v}{N_A}\right)$$

For p-type,  $p \sim$  density of acceptors,  
 $n = n_i^2 / N_A$

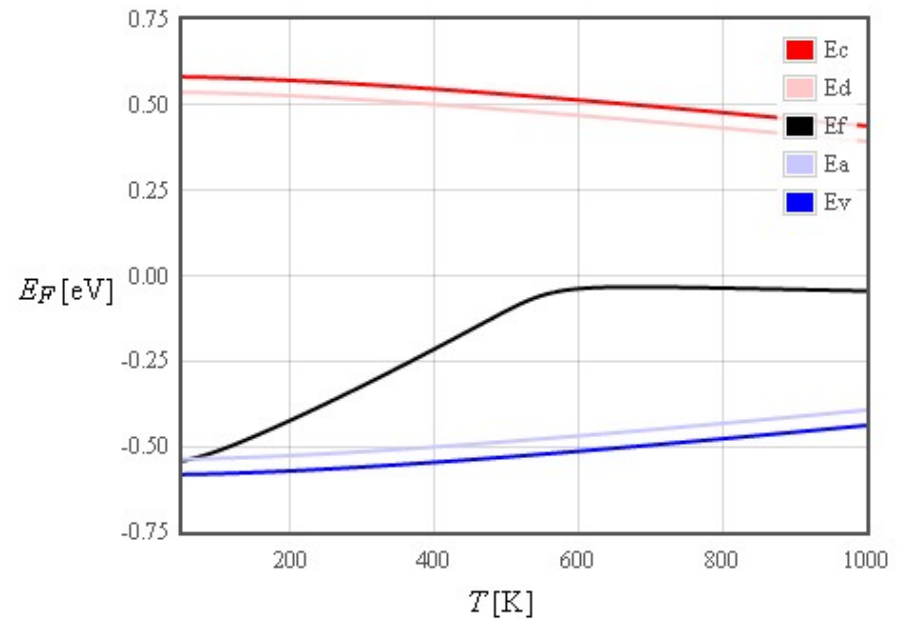
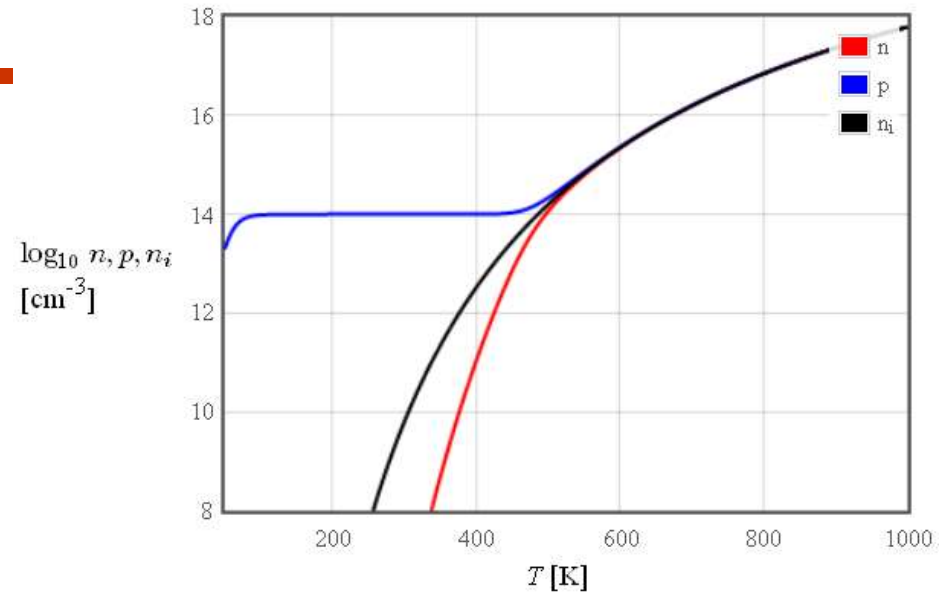

# Intrinsic / Extrinsic

---

Intrinsic:  $n = p$

Conductivity strongly temperature dependent near room temperature

Extrinsic:  $n \neq p$

Conductivity almost temperature independent at room temperature

# Why dope with donors AND acceptors?

---

Bipolar transistor

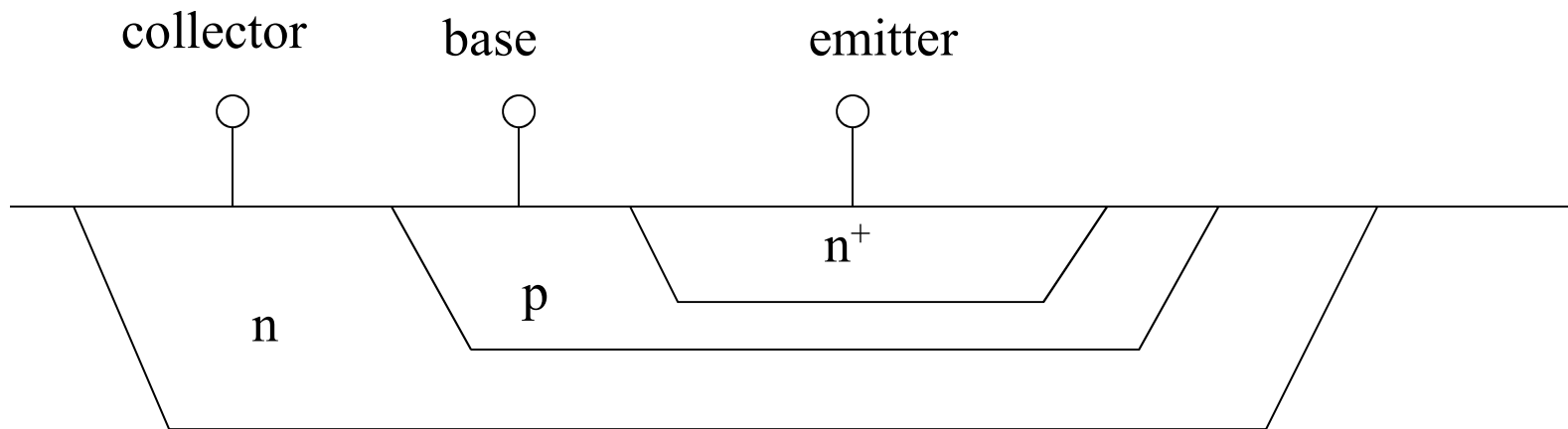

lightly doped p substrate



# MOSFET

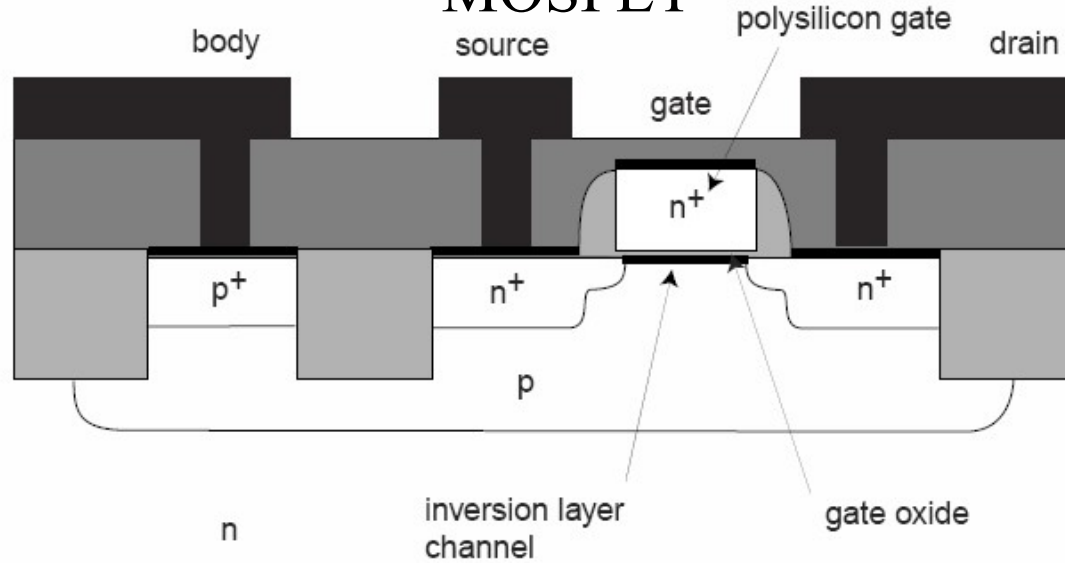

# Bipolar Junction Transistor

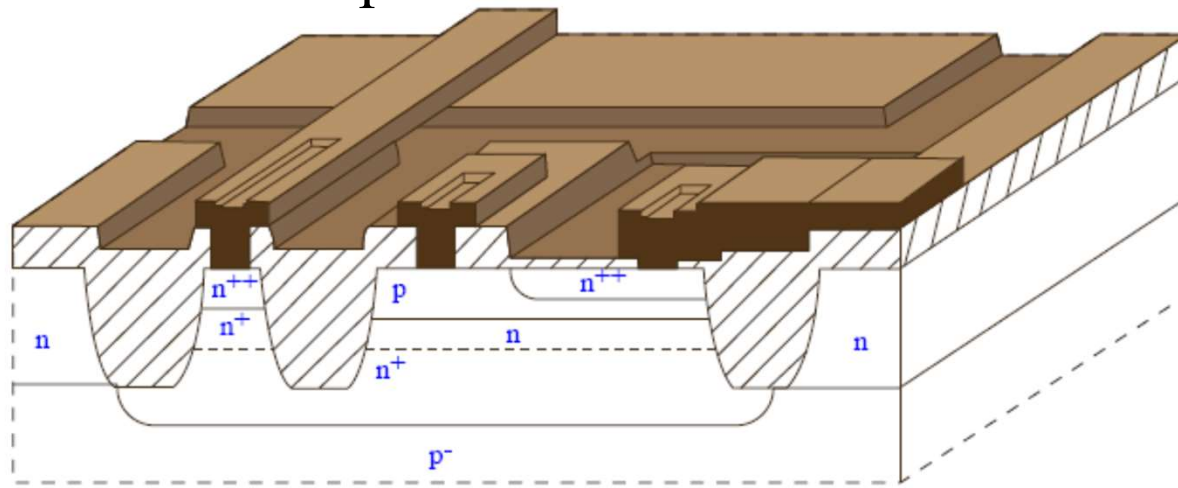

**Oxide isolated integrated BJT - a modern process**

degenerately doped semiconductor

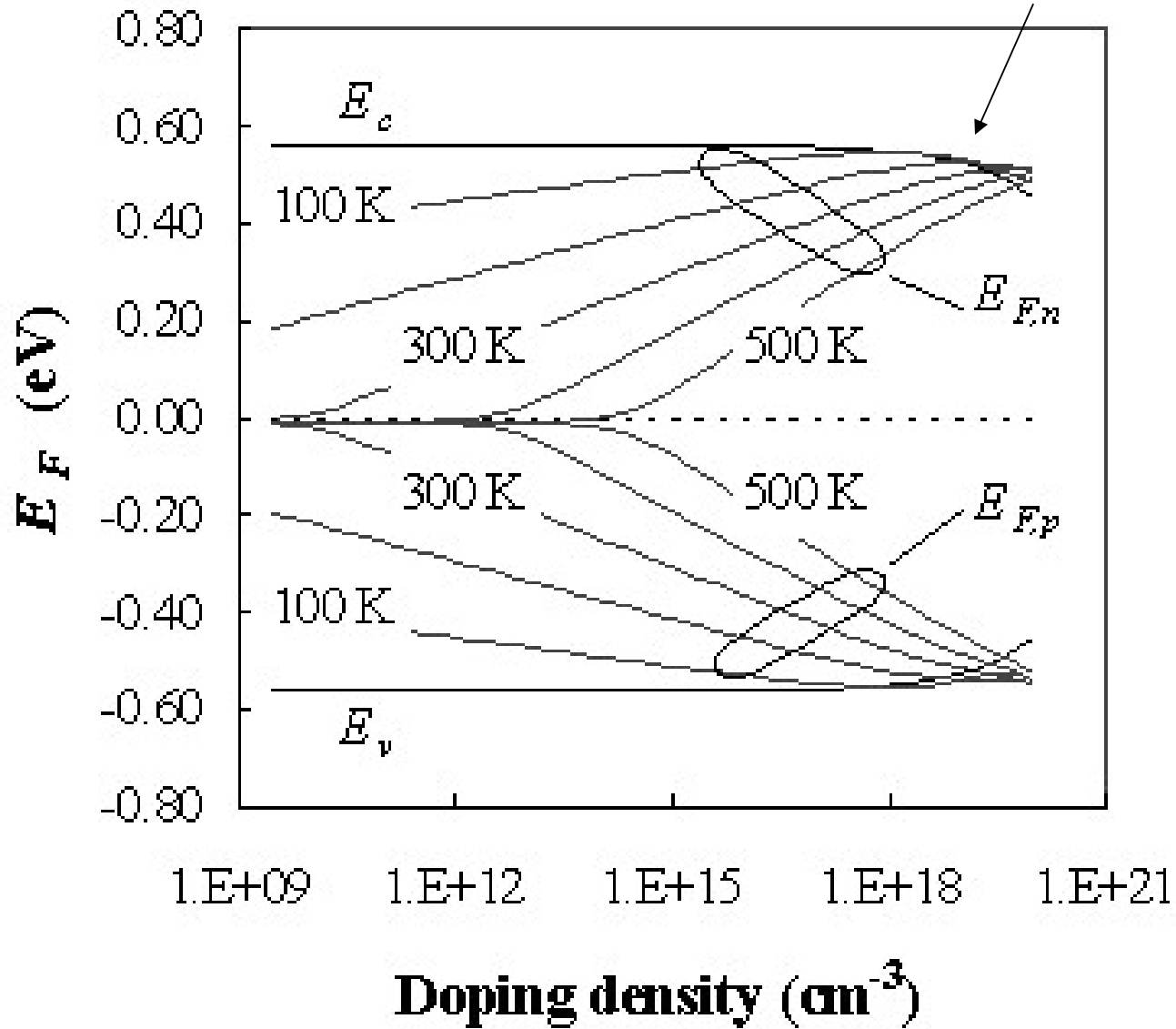

# Degenerate semiconductor

---

Heavily doped semiconductors are called degenerately doped

$N_D > 0.1 N_c \rightarrow E_F$  in the conduction band

$N_A > 0.1 N_v \rightarrow E_F$  in the valence band

Heavy doping narrows the band gap

The Boltzmann approximation is not valid

Degenerate semiconductors = metal

# Carrier transport

---

# Carrier Transport

---

Ballistic transport

Drift

Diffusion

Tunneling

# Ballistic transport

---

$$\vec{F} = m\vec{a} = -e\vec{E} = m \frac{d\vec{v}}{dt}$$

$$\vec{v} = \frac{-e\vec{E}t}{m} + \vec{v}_0$$

$$\vec{x} = \frac{-e\vec{E}t^2}{2m} + \vec{v}_0t + \vec{x}_0$$

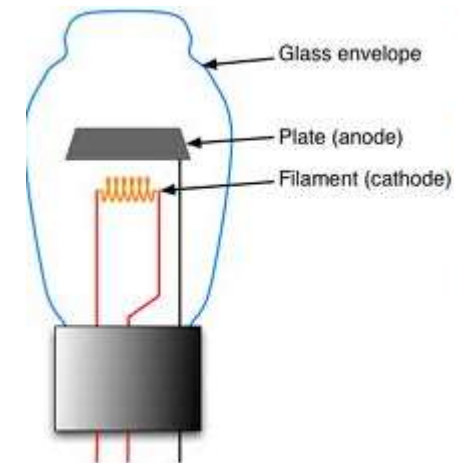

Electrons moving in an electric field follow parabolic trajectories like a ball in a gravitational field.

# Drift

The electrons scatter and change direction after a time  $\tau_{sc}$ .

Classical equipartition:  $\frac{1}{2} m v_{th}^2 = \frac{3}{2} k_B T$

At 300 K,  $v_{th} \sim 10^7$  cm/s.

mean free path:  $\ell = v_{th} \tau_{sc} \sim 10$  nm  $\sim 200$  atoms

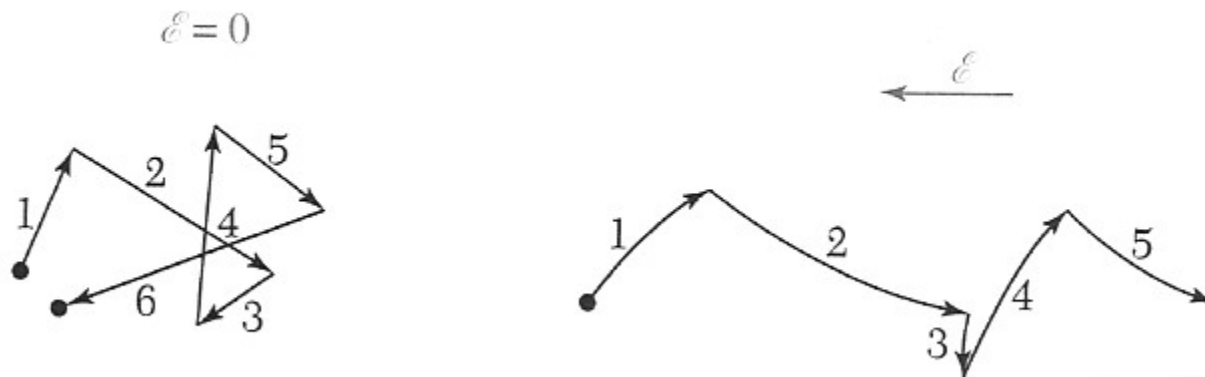

# Drift (diffusive transport)

---

$$\vec{F} = -e\vec{E} = m^* \vec{a} = m^* \frac{d\vec{v}}{dt}$$

$$\vec{v} = \vec{v}_0 - \frac{e\vec{E}}{m^*} (t - t_0)$$

$$\langle \vec{v}_0 \rangle = 0 \quad \langle t - t_0 \rangle = \tau_{sc}$$

*time between two collisions*

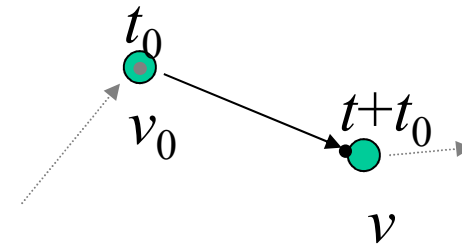

$$\vec{v}_d = \frac{-e\vec{E}\tau_{sc}}{m^*} = \frac{-e\vec{E}\ell}{m^* v}$$

drift velocity:  $\vec{v}_{d,n} = -\mu_n \vec{E}$

$$\vec{v}_{d,p} = \mu_p \vec{E}$$



# Drift

---

drift velocity:  $\vec{v}_{d,n} = -\mu_n \vec{E}$        $\vec{v}_{d,p} = \mu_p \vec{E}$

$$\vec{j} = -ne\vec{v}_{d,n} + pe\vec{v}_{d,p} = (ne\mu_n + pe\mu_p) \vec{E} = \sigma \vec{E} \quad (\text{Ohm's law})$$

$$\mu = \frac{-e\tau_{sc}}{m^*} = \frac{-e\ell}{m^* v}$$

for Si:  $\mu_n = 1350 \text{ cm}^2/\text{Vs}$   
 $\mu_p = 450 \text{ cm}^2/\text{Vs}$

For  $E = 1000 \text{ V/cm}$        $v_d = 10^6 \text{ cm/s}$

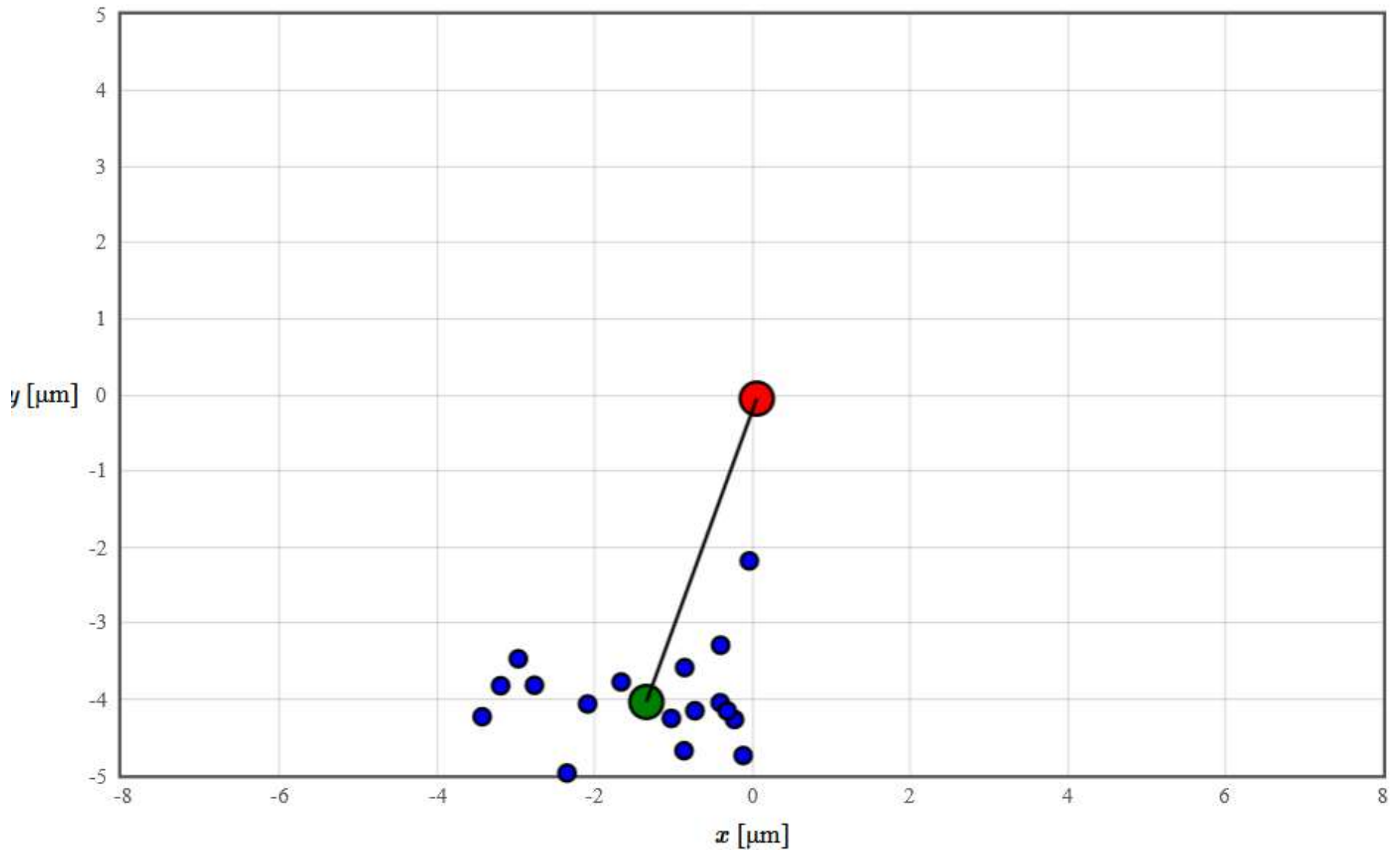

<http://lampx.tugraz.at/~hadley/psd/L5/drude.php>

# Drift

		$E_g$ (eV)	$\mu_n$ (cm <sup>2</sup> /V-s)	$\mu_p$ (cm <sup>2</sup> /V-s)	$m_n^*/m_0$ ( $m_l, m_t$ )	$m_p^*/m_0$ ( $m_{lh}, m_{hh}$ )	$a$ (Å)	$\epsilon_r$	Density (g/cm <sup>3</sup> )	Melting point (°C)
Si	(i/D)	1.11	1350	480	0.98, 0.19	0.16, 0.49	5.43	11.8	2.33	1415
Ge	(i/D)	0.67	3900	1900	1.64, 0.082	0.04, 0.28	5.65	16	5.32	936
SiC ( $\alpha$ )	(i/W)	2.86	500	—	0.6	1.0	3.08	10.2	3.21	2830
AlP	(i/Z)	2.45	80	—	—	0.2, 0.63	5.46	9.8	2.40	2000
AlAs	(i/Z)	2.16	1200	420	2.0	0.15, 0.76	5.66	10.9	3.60	1740
AlSb	(i/Z)	1.6	200	300	0.12	0.98	6.14	11	4.26	1080
GaP	(i/Z)	2.26	300	150	1.12, 0.22	0.14, 0.79	5.45	11.1	4.13	1467
GaAs	(d/Z)	1.43	8500	400	0.067	0.074, 0.50	5.65	13.2	5.31	1238
GaN	(d/Z, W)	3.4	380	—	0.19	0.60	4.5	12.2	6.1	2530
GaSb	(d/Z)	0.7	5000	1000	0.042	0.06, 0.23	6.09	15.7	5.61	712
InP	(d/Z)	1.35	4000	100	0.077	0.089, 0.85	5.87	12.4	4.79	1070
InAs	(d/Z)	0.36	22600	200	0.023	0.025, 0.41	6.06	14.6	5.67	943
InSb	(d/Z)	0.18	10 <sup>5</sup>	1700	0.014	0.015, 0.40	6.48	17.7	5.78	525
ZnS	(d/Z, W)	3.6	180	10	0.28	—	5.409	8.9	4.09	1650*
ZnSe	(d/Z)	2.7	600	28	0.14	0.60	5.671	9.2	5.65	1100*
ZnTe	(d/Z)	2.25	530	100	0.18	0.65	6.101	10.4	5.51	1238*
CdS	(d/W, Z)	2.42	250	15	0.21	0.80	4.137	8.9	4.82	1475
CdSe	(d/W)	1.73	800	—	0.13	0.45	4.30	10.2	5.81	1258
CdTe	(d/Z)	1.58	1050	100	0.10	0.37	6.482	10.2	6.20	1098
PbS	(i/H)	0.37	575	200	0.22	0.29	5.936	17.0	7.6	1119
PbSe	(i/H)	0.27	1500	1500	—	—	6.147	23.6	8.73	1081
PbTe	(i/H)	0.29	6000	4000	0.17	0.20	6.452	30	8.16	925

Solid state electronic devices, Streetman and Banerjee

$$\vec{v}_{d,n} = -\mu_n \vec{E}$$

$$\vec{v}_{d,p} = \mu_p \vec{E}$$

$$\vec{j} = -nev_{d,n} + pev_{d,p} = (ne\mu_n + pe\mu_p) \vec{E} = \sigma \vec{E}$$

# Matthiessen's rule

---

$$\frac{1}{\tau_{sc}} = \frac{1}{\tau_{sc,lattice}} + \frac{1}{\tau_{sc,impurity}}$$

↑  
phonons, temperature dependent

↑ mostly temperature independent

$$\frac{1}{\mu} = \frac{1}{\mu_{lattice}} + \frac{1}{\mu_{impurity}}$$

$$\sigma = \frac{1}{\rho} = ne\mu_n + pe\mu_p$$

↑  
doping increases the conductivity  
by increasing the carrier density  
but decreases the mobility

$$\mu_e = 88 \left( \frac{T}{300} \right)^{-0.57} + \frac{7.4 \times 10^8 T^{-2.33}}{1 + 0.88 \left[ \frac{N_d}{1.26 \times 10^{17} \left( \frac{T}{300} \right)^{2.4}} \right]} \text{ cm}^2/\text{V s},$$

$$\mu_h = 54.3 \left( \frac{T}{300} \right)^{-0.57} + \frac{1.36 \times 10^8 T^{-2.33}}{1 + 0.88 \left[ \frac{N_a}{2.35 \times 10^{17} \left( \frac{T}{300} \right)^{2.4}} \right]} \text{ cm}^2/\text{V s}.$$

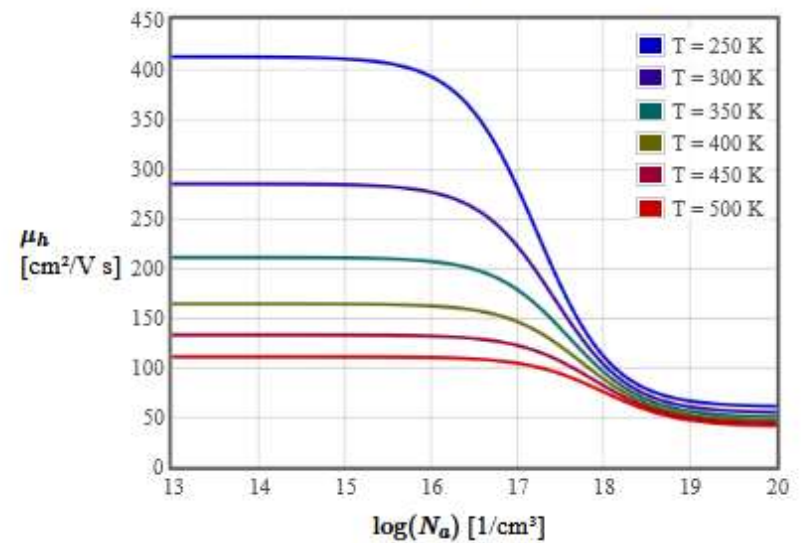
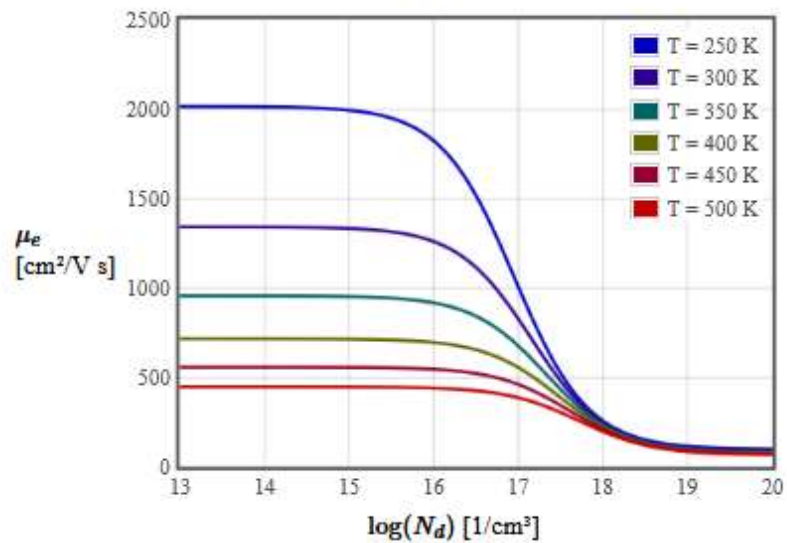
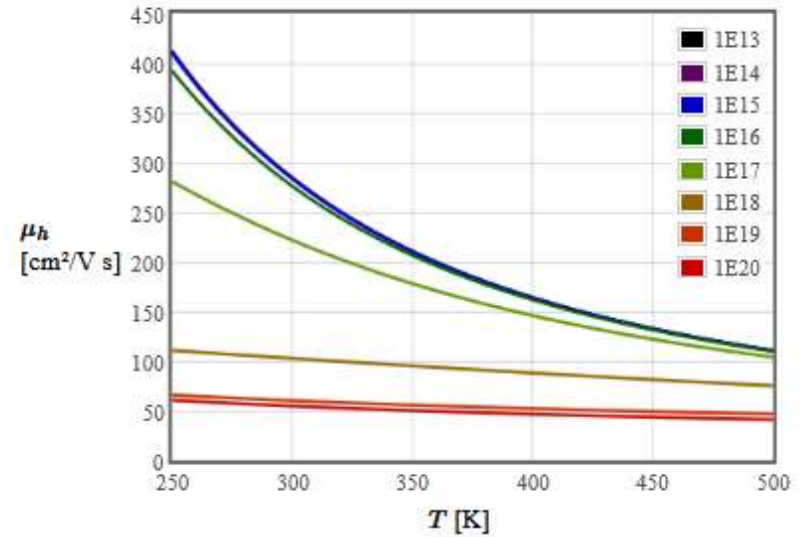
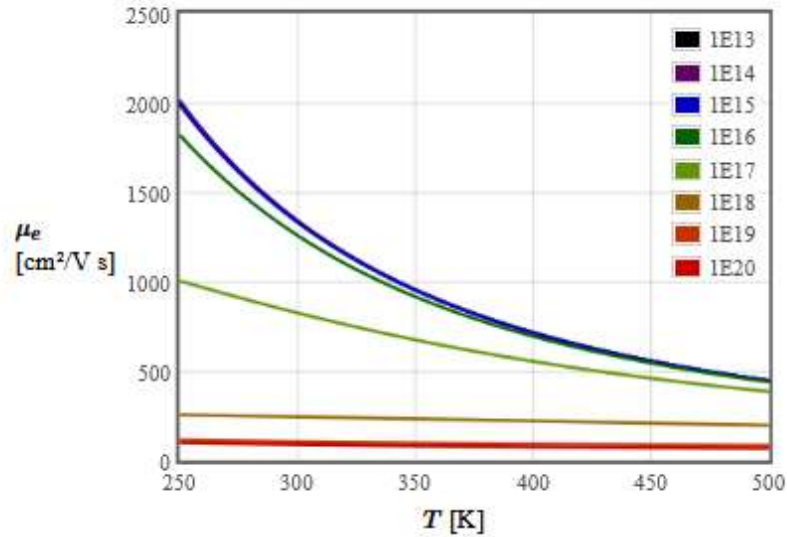

# Conductivity of Silicon

---

$$\sigma = ne\mu_n + pe\mu_p$$

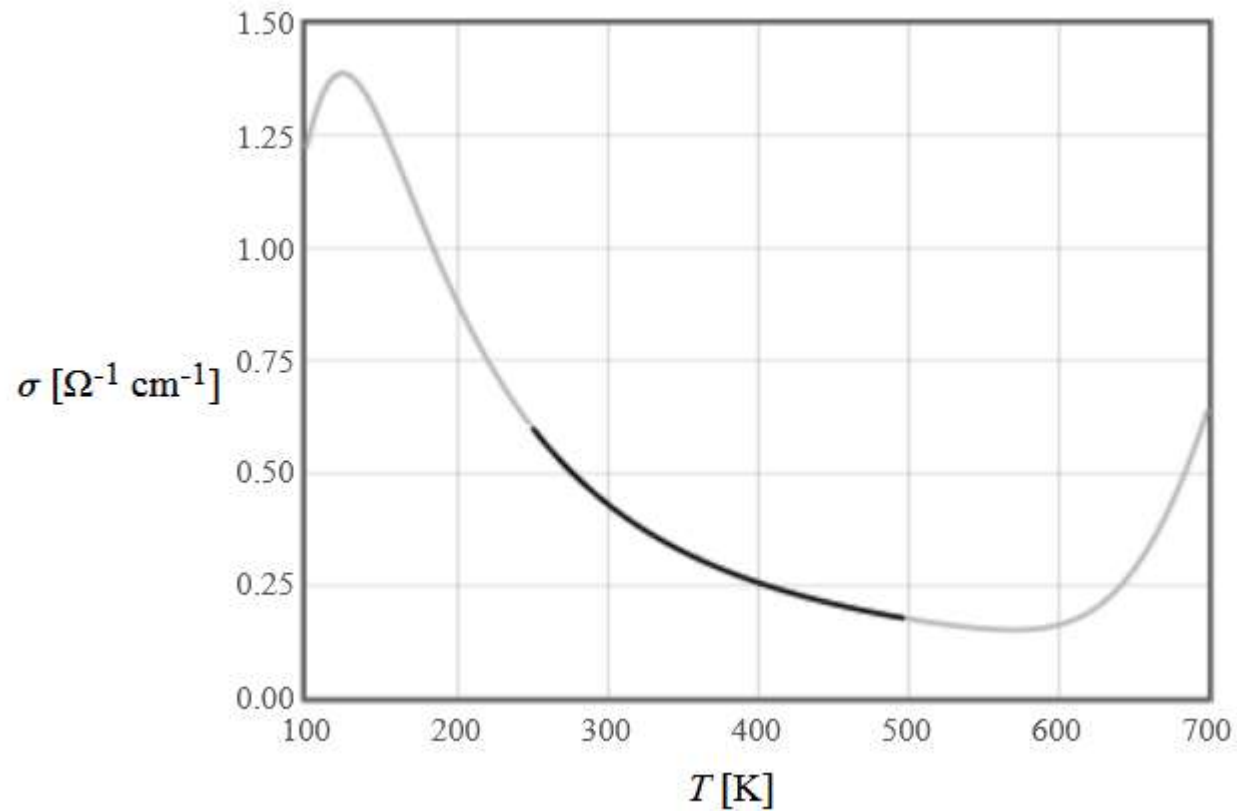

$$N_A = 10^{16} \text{ 1/cm}^3$$

<http://lampx.tugraz.at/~hadley/psd/L4/conductivity.php>

# Ballistic transport in transistors

---

The mean free path  $\sim 100$  nm  $>$  gate length  $\sim 20$  nm

$v$  not proportional to  $E$

$$\vec{v} = \mu \vec{E}$$

$j$  not proportional to  $E$

$$\vec{j} = \sigma \vec{E}$$

nonlocal response

Electrons bend in a magnetic field like they do in vacuum.

# Crossed $E$ and $B$ fields

Ballistic transport

$$\vec{F} = m\vec{a} = -e(\vec{E} + \vec{v} \times \vec{B})$$

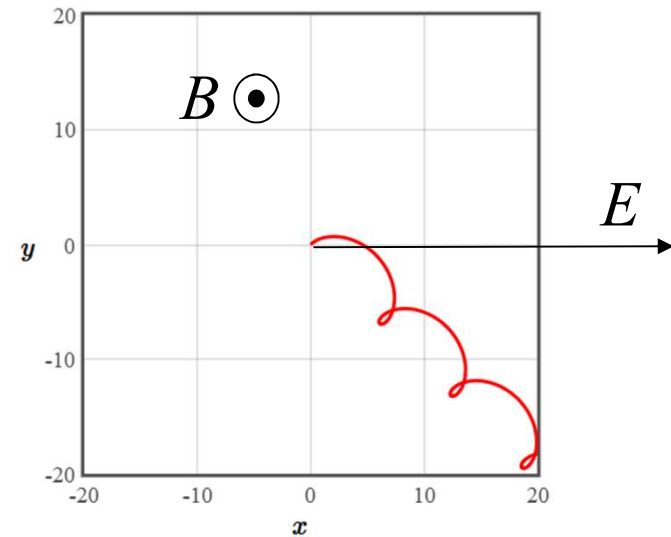

Diffusive transport

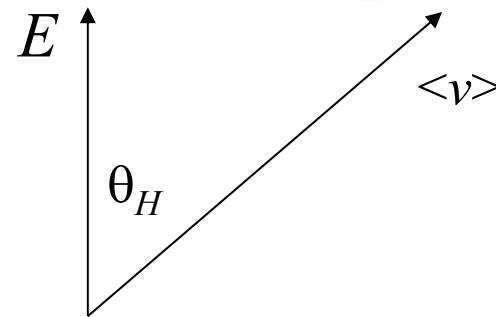

Hall angle:

$$\theta_H = \tan^{-1} \left( -\frac{eB_z \tau_{sc}}{m^*} \right)$$